

# **OPERATING MANUAL**

# **TRITON**

# **450 PS | 600 PS**



**Edition: 3 | effective from: 1. 1. 2022**

Dear customer,

Semi-carried cultivators **TRITON** are quality products of Farmet a.s. Ceska Skalice.

You can fully utilise the advantages of your machine after thoroughly studying the operating manual.

The serial number of the machine is punched on the production label and written in the operating manual (see Table 1). This machine serial number must be stated whenever ordering spare parts for possible repairs. The production label is located on the middle frame near the tow bar.

Use only spare parts for these machines according to the **Spare parts catalogue** officially issued by the manufacturer, Farmet a.s. Ceska Skalice.

**Possibilities of Use of the Cultivator**

The **TRITON** cultivator is designed for cultivation of all types of soils up to a processing depth of 350 mm.

Production label of the machine **TRITON 450 PS**

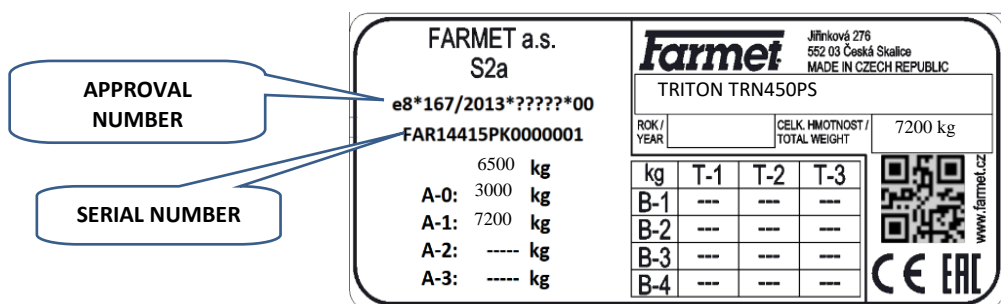

The image shows a production label for the TRITON 450 PS cultivator. It includes the Farmet logo, company address (Jilínková 276, 552 03 Česká Skalice, MADE IN CZECH REPUBLIC), and model name (TRITON TRN450PS). Key specifications include a total weight of 7200 kg and a table of weights for different implements (T-1, T-2, T-3, B-1, B-2, B-3, B-4). A QR code and CE EAC certification are also present. Two callout boxes point to the approval number (e8\*167/2013\*????\*00) and the serial number (FAR14415PK0000001).

Production label of the machine **TRITON 600 PS**

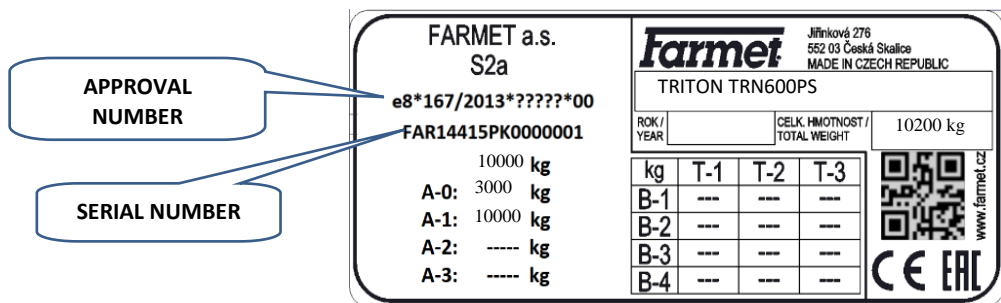

The image shows a production label for the TRITON 600 PS cultivator. It includes the Farmet logo, company address (Jilínková 276, 552 03 Česká Skalice, MADE IN CZECH REPUBLIC), and model name (TRITON TRN600PS). Key specifications include a total weight of 10200 kg and a table of weights for different implements (T-1, T-2, T-3, B-1, B-2, B-3, B-4). A QR code and CE EAC certification are also present. Two callout boxes point to the approval number (e8\*167/2013\*????\*00) and the serial number (FAR14415PK0000001).

Table 1 – Your Machine Characteristic

<b>MACHINE TYPE</b>	
<b>MACHINE SERIAL NUMBER</b>	
<b>SPECIAL DESIGN OR ACCESSORIES</b>	
	.....
	.....
	.....
	.....

## TABLE OF CONTENTS

MACHINE LIMIT PARAMETERS .....	4
A. GENERAL INSTRUCTIONS FOR USE .....	7
B. MACHINE TRANSPORT USING TRANSPORT MEANS .....	8
C. MACHINE HANDLING USING LIFTING EQUIPMENT .....	9
D. WORK SAFETY LABELS .....	11
1 DESCRIPTION .....	14
1.1 MACHINE SECTION ARRANGEMENT .....	14
1.2 WORK PARTS OF THE MACHINE .....	14
2 HYDRAULICS .....	16
2.1 HYDRAULICS OF THE MACHINE .....	17
2.2 USING THE HYDRAULICS CONTROL PANEL .....	19
2.3 COMPLETE HYDRAULIC SCHEME OF MACHINE .....	21
3 BRAKE SYSTEM.....	22
3.1 SERVICE BRAKE .....	22
3.2 USE OF HAND BRAKE .....	24
4 MACHINE ASSEMBLY AT THE CUSTOMER .....	25
5 COMMISSIONING .....	25
6 AGGREGATION TO A TRACTOR.....	26
7 FOLDING AND UNFOLDING OF THE MACHINE .....	27
8 MACHINE TRANSPORT ON ROADS .....	28
8.1 SHARP MACHINE PROJECTION .....	30
9 MACHINE ADJUSTMENT .....	31
9.1 WORKING DEPTH ADJUSTMENT.....	31
9.2 ADJUSTING THE LEVELLING DISCS .....	35
9.3 WORKING DEPTH SETTING WHEN WORKING WITHOUT ROLLERS.....	37
10 MACHINE MAINTENANCE AND REPAIR .....	39
11 MACHINE STORAGE .....	43
12 MACHINE LUBRICATION SCHEDULE .....	44
13 ENVIRONMENTAL PROTECTION .....	45
14 MACHINE DISPOSAL AFTER SERVICE LIFE EXPIRY .....	45
15 SERVICING AND WARRANTY CONDITIONS .....	45
15.1 SERVICING .....	45
15.2 WARRANTY.....	45

## MACHINE LIMIT PARAMETERS

- <sup>(x)</sup> The machine is designed for soil cultivation when agricultural soil cultivation. Another type of use exceeding the determined purpose is forbidden.
- <sup>(x)</sup> The machine is only operated by one person - the tractor operator.
- <sup>(x)</sup> Machine operator must not use the machine in a different way, especially:
  - <sup>(x)</sup> Transport of persons and animals on the machine structure,
  - <sup>(x)</sup> Transport of burdens on the machine structure,
- <sup>(x)</sup> Aggregation of the machine with another towing equipment than stated in Chapter „6./p.27“.

## TECHNICAL PARAMETERS

Table 2 – technical parameters

PARAMETERS		TRITON 450		TRITON 600	
Working width (mm)		4 500		6 000	
Transport width (mm)		3 000		3 000	
Transport height (mm)		3 370		3 950	
Machine total length (mm)		9 500		9 550	
Working depth (mm) shares/discs		30-350/50-120*		30-350/50-120*	
Number of shares		11		15	
Number of discs		38		50	
Working performance (ha/h)		3,6 – 5,4		4,8-7,2	
Towing means (kW)		225-350**		350-460**	
Working speed (kph)		8-12		8-12	
Maximum transport speed (kph)		30		30	
Maximum slope grade (°)		6		6	
Tyre dimensions - transport port	Tyre pressure (kPa)	550/45-22,5	480	550/45-22,5	480
Machine weight (kg)		8 100***		10 200***	

\* For discs diameter 510 and 560 mm, working depth setting is described in detail in Chap. 9.1/p.31

\*\* Recommended towing means, the real towing force may significantly vary according to the processing depth, soil conditions, land slope, working body wear and adjustment

\*\*\* For the heaviest version with a double roller and an additional weight

**WEIGHT DISTRIBUTION ON THE MACHINE DURING TRANSPORT**

**TRITON 450 PS**

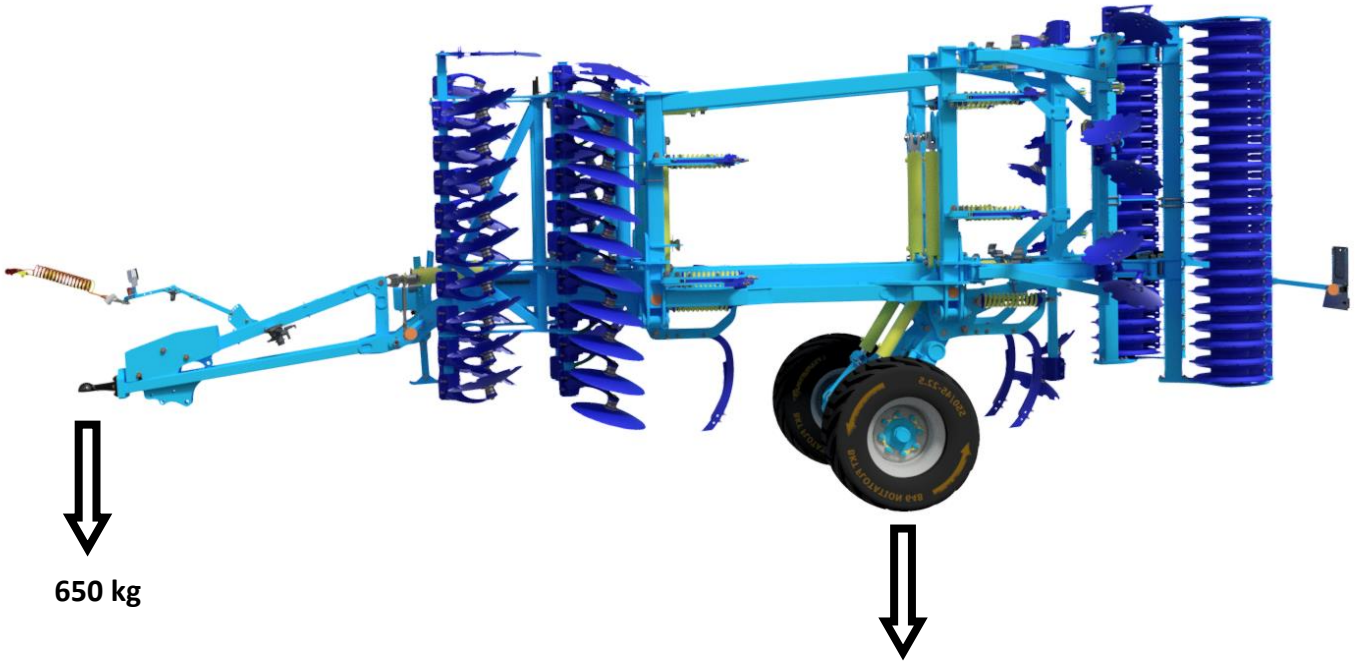

**TRITON 600 PS**

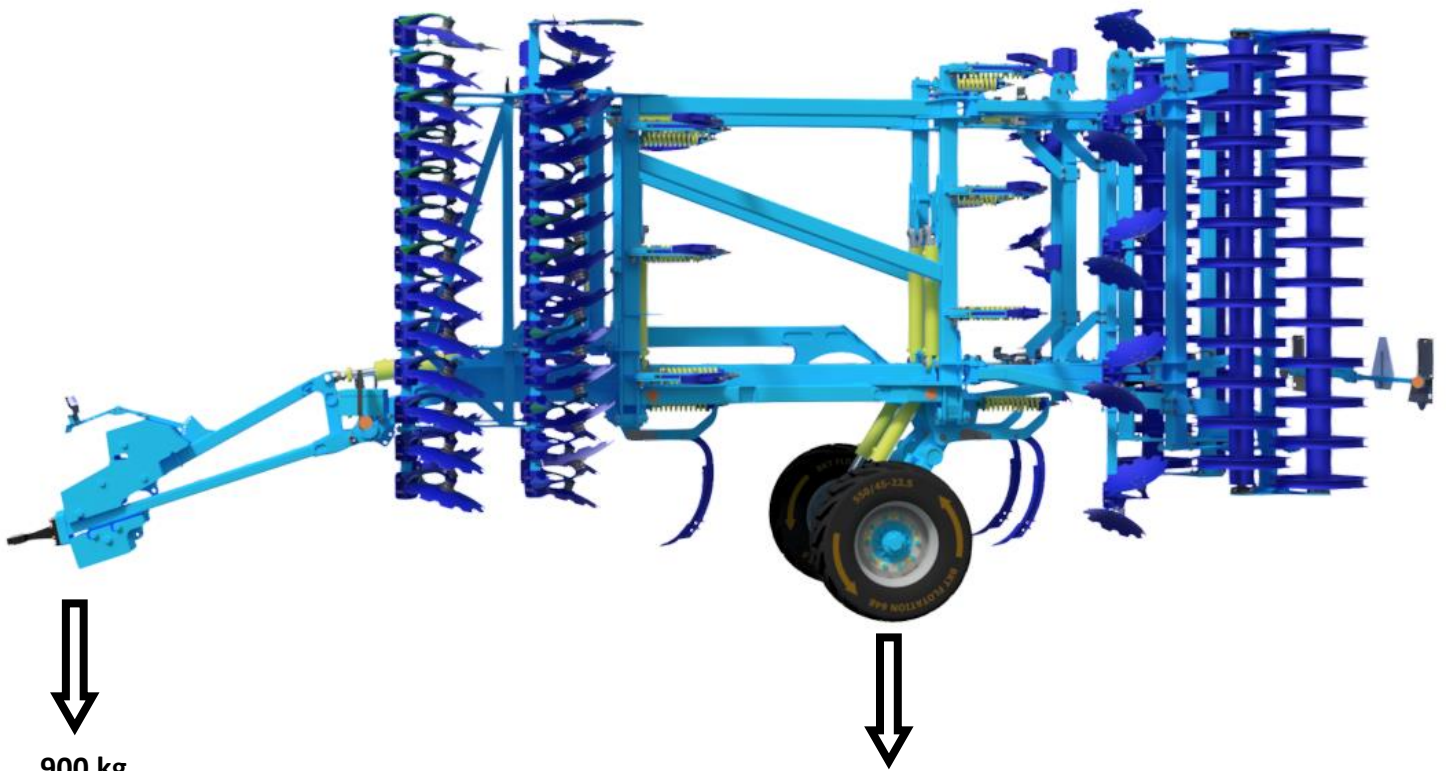

7 450 kg

900 kg

9 300 kg

Stated weights are valid for the heaviest version with double roller and additional counterweight.

## SAFETY STATEMENT

	This warning sign warns about an immediate dangerous situation ending with death or severe injury.
	This warning sign warns about a dangerous situation ending with death or severe injury.
	This warning sign warns about a situation that may end with a smaller or slight injury. It also warns about dangerous actions related to the activity that could lead to an injury.





### PROTECTIVE TOOLS

For the operation and maintenance use

- Tight clothes
- Protective gloves and goggles for protection against dust and sharp parts of the machine



## A. GENERAL INSTRUCTIONS FOR USE

- A.1** The machine is made in accordance with the latest equipment state and approved safety regulations. However, dangers of user or third person injury or machine damage or creation of other material damage may arise during use.
- A.2** Use the machine only in a technically sound condition, in accordance with its purpose, aware of possible dangers, and while adhering to the safety instructions of this operating manual!  
The manufacturer is not liable for damages caused by the use of the machine that is in contradiction with the limit parameters of the machine and with the instructions for the use of the machine. The user bears the risk.  
Immediately remove especially the failures that may negatively affect safety!
- A.3** <sup>(7)</sup> Machine operation may be performed by a person authorised by the operator under these conditions:
- <sup>(8)</sup> It must own a valid driver's licence of the corresponding category,
  - <sup>(9)</sup> It must be demonstrably familiarised with the safety regulations for work with the machine and must practically master the machine operation,
  - <sup>(10)</sup> The machine may not be operated by juveniles,
  - <sup>(11)</sup> It must know the meaning of the safety signs located on the machine. Their respecting is important for safe and reliable machine operation.
- A.4** <sup>(12)</sup> Maintenance and servicing repairs on the machine may only be performed by a person:
- <sup>(13)</sup> Authorised by the operator,
  - <sup>(14)</sup> Educated in the machinery field with knowledge of repairs of similar machines,
  - <sup>(15)</sup> Demonstrably familiarised with safety regulations for work with the machine,
  - <sup>(16)</sup> During a repair of a machine connected to a tractor, it must own a driver's licence of the corresponding category.
- A.5** <sup>(17)</sup> Machine operator must secure the safety of other persons when working with the machine or transporting the machine.
- A.6** <sup>(18)</sup> During machine work in the field or during transport, the operator must control the machine from the tractor's cabin.
-  **A.7** <sup>(19)</sup> The operator may enter the machine structure only with the machine at rest and blocked against movement, namely only for these reasons:
- <sup>(20)</sup> Adjustment of the machine working parts,
  - <sup>(21)</sup> Repair and maintenance of the machine,
  - <sup>(28)</sup> Adjustment of the working parts of the machine after unfolding the side frames.
-  **A.8** When climbing on the machine, do not step on the axle tyres, rollers or other revolving parts. Those may turn and you can cause very serious injuries by the subsequent fall.
-  **A.9** <sup>(22)</sup> Any changes or modifications of machine may be performed only with written consent of the manufacturer. For possible damage arisen due to ignoring this instruction, the producer bears no responsibility. The machine must be maintained equipped with prescribed accessories and equipment including safety marking. All warning and safety signs must be legible and in their places. In case of damage or loss, these signs must be immediately renewed.
- A.10** <sup>(23)</sup> The operator must have the Operating Manual with the work safety requirements available at any time when working with the machine.
-  **A.11** <sup>(24)</sup> The operator must not consume alcohol, medicines, narcotic and hallucinogenic substances that decrease his attention and coordination capabilities while using the machine. If the operator must use medicines prescribed by a physician or uses freely sold medicines, he must be informed by a physician, whether he is capable of responsible and safe operation of the machine under these circumstances.



## B. MACHINE TRANSPORT USING TRANSPORT MEANS

- B.1 <sup>(1)</sup> The transport means designed for machine transport must have the load capacity minimally identical with the weight of the transported machine. The total weight of the machine is stated on the production label.
- B.2 <sup>(2)</sup> The dimensions of the transported machine including the transport means must comply with the valid regulations for road traffic (decrees, laws).
-  B.3 <sup>(3)</sup> The transported machine must be always fastened to the transport means so that its spontaneous loosening could not happen.
- B.4 <sup>(4)</sup> The carrier is responsible for damage caused by the loosening of incorrectly or insufficiently fastened machine to the transport means.
- B.5 <sup>(5)</sup> To fasten the machine, use the recommended points shown in the picture.
- B.6 <sup>(6)</sup> The transport connecting rod must be installed on the machine and properly secured, all three ball valves must be closed.

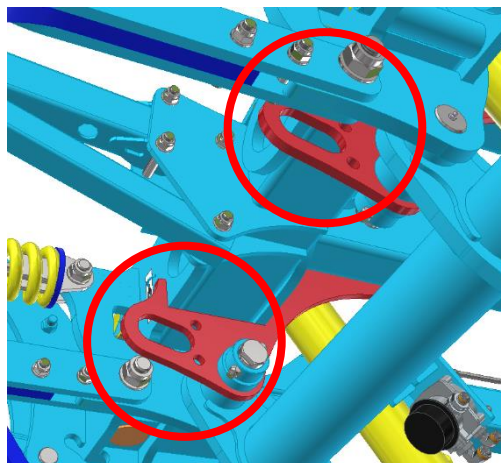
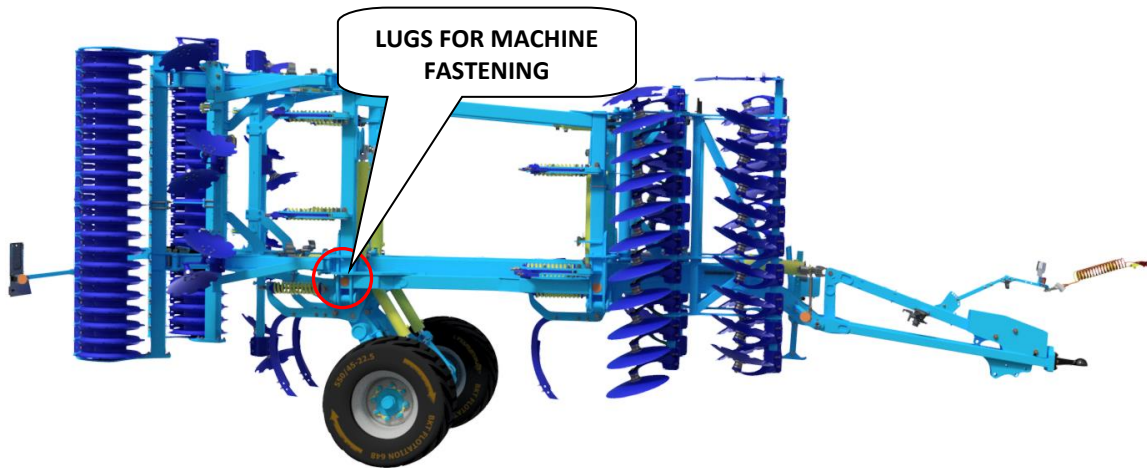



## C. MACHINE HANDLING USING LIFTING EQUIPMENT

- C.1 The lifting equipment and tying means designed for handling of the machine must have their load capacity at least identical with the weight of the handled machine.
-  C.2 <sup>(2)</sup> Machine fastening for handling may only be performed in places designed for that and marked with self-adhesive labels showing the "chain" symbol. —○—○—
- C.3 The lugs for machine fastening are located identically on both side frames of the machine, see the pictures.
- C.4 <sup>(3)</sup> After fastening (suspending) at designated points, it is forbidden to move in the space of possible reach of the handled machine.
- C.5 Do not use the lugs on the roller supports under any circumstances when manipulating with the whole machine. The lugs are only designed for replacing rollers and their maximum load capacity is 500 kg (as shown on the label near the lugs).

### HANDLING OF THE WHOLE MACHINE

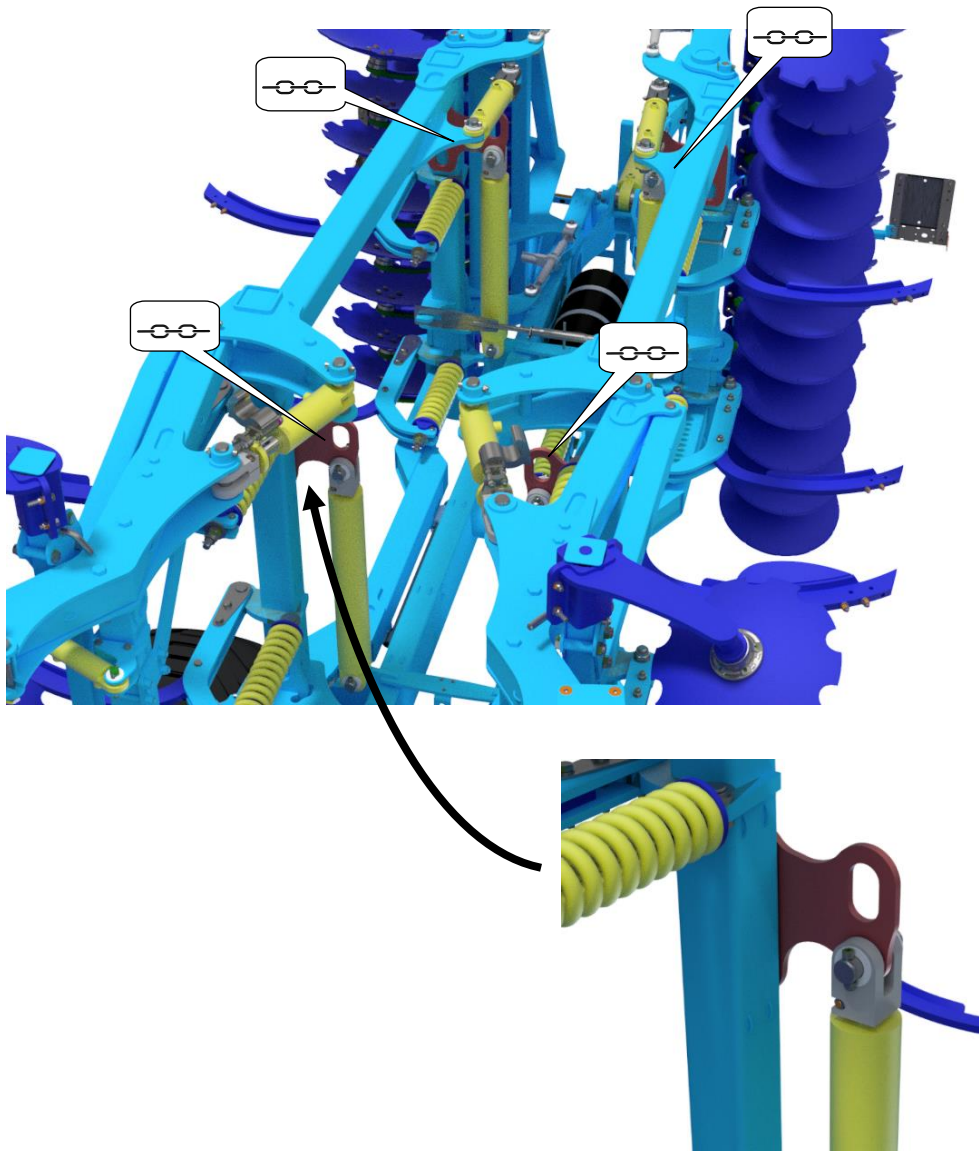

## HANDLING OF ROLLERS ONLY

- Use only when replacing rollers. **Bearing capacity of one shackle is 500 kg maximum.**

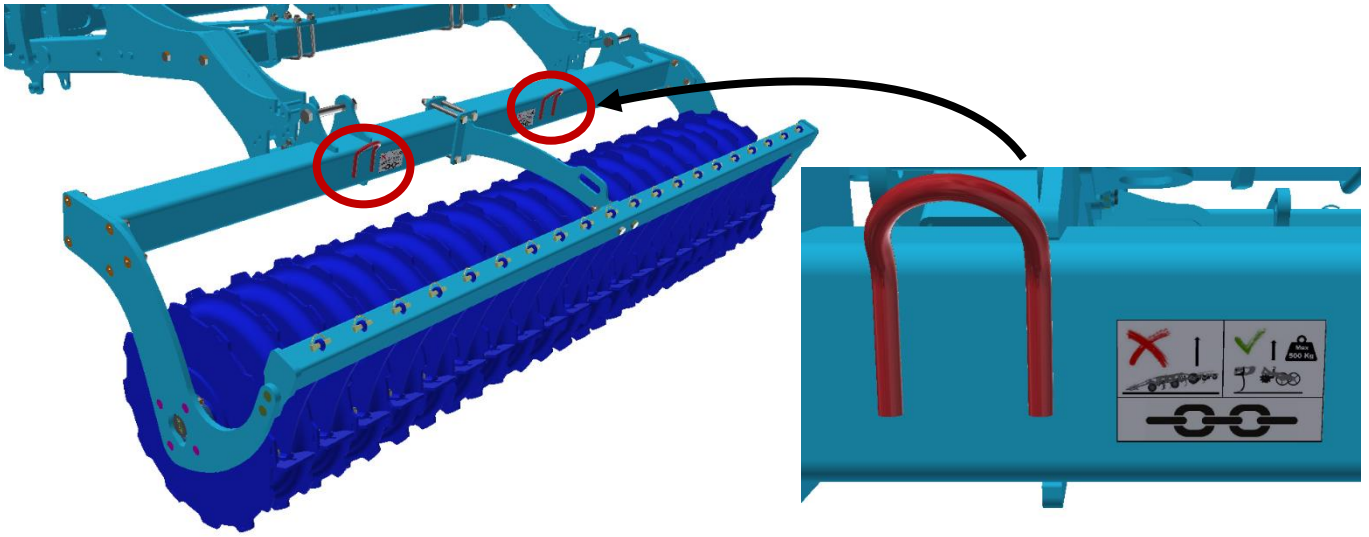

## D. WORK SAFETY LABELS





- Warning safety labels serve for operator protection.

General:

- Strictly observe the warning safety labels.
- All safety instructions also apply to other users.  
Upon damage or destruction of the aforementioned "SAFETY LABEL" located on the machine, THE OPERATOR IS OBLIGED TO REPLACE IT WITH A NEW ONE!!!

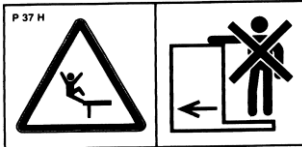
The position, appearance, and precise meaning of work safety labels on the machine is determined in the following tables (Tab. 3) and in the figure (Fig. 1).

Table 3 – Self-adhesive warning safety labels located on the cultivator

WARNING SAFETY LABEL	LABEL TEXT	MACHINE POSITION
	<p>Before handling the machine, carefully read the operating manual.</p> <p>Observe the instructions and safety regulations for machine operation during use.</p>	<b>P 1 H</b>
	<p>Travelling and transport on the machine structure is strictly forbidden.</p>	<b>P 37 H</b>
	<p>When connecting or disconnecting, do not step between the tractor and the machine, also do not enter this space, if the tractor and the machine are not at rest and the engine is not turned off.</p>	<b>P 2 H</b>
	<p>When folding and unfolding the side frames, stay outside their reach.</p>	<b>P 50 H</b>
	<p>Stay outside the reach of the tractor - agricultural machine set, if the tractor engine is in operation.</p>	<b>P 6 H</b>
	<p>When folding the side frames, do not reach into the space of the machine folding joints.</p> <p>There is a danger of cutting when setting the depth of the machine.</p>	<b>P 20 H</b>

	<p>Before commencing the machine transport, secure the axle with spherical valves against unexpected drop.</p>	<p><b>P 13 H</b></p>
	<p>When working and transporting the machine, maintain safe distance from the electric appliances.</p>	<p><b>P 39 H</b></p>
	<p>Secure the machine against unwanted movement by positioning on its working bodies.</p>	<p><b>P 52 H</b></p>
	<p>Stay outside the reach of the tractor - agricultural machine set, if the tractor engine is in operation.</p>	<p><b>P 53 H</b></p>
	<p>The shown positions of the lever and the function of the hydraulic spherical valve located on the piston rod.</p>	<p><b>P 101 H</b></p>
	<p>Before commencing the machine transport, secure the axle with spherical valves against unexpected drop.</p>	<p><b>P 100 H</b></p>

Fig.1 – Location of safety labels on the machine **TRITON**



# 1 DESCRIPTION

The **TRITON 450PS** and **TRITON 600 PS** are designed as semi-carried and folding. The basic version consists of the drawbar, which connects to the pulling vehicle according to the corresponding equipment. Then, there is a central frame with the transport axle and two side frames. On side frames, there are discs in two rows and plough shares in another two rows with automatic spring protection. Behind the second row of plough shares there is a row of levelling discs to level the soil. The machine ends with rollers which compact the loosened soil.

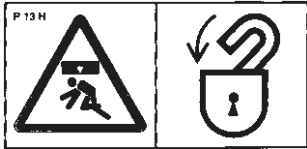
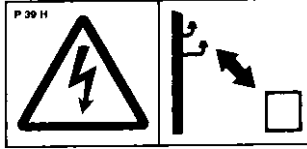
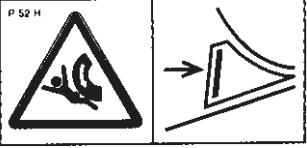
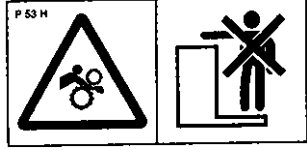
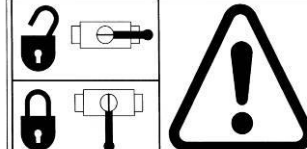
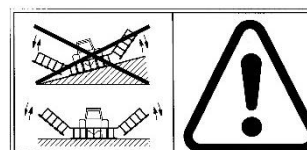
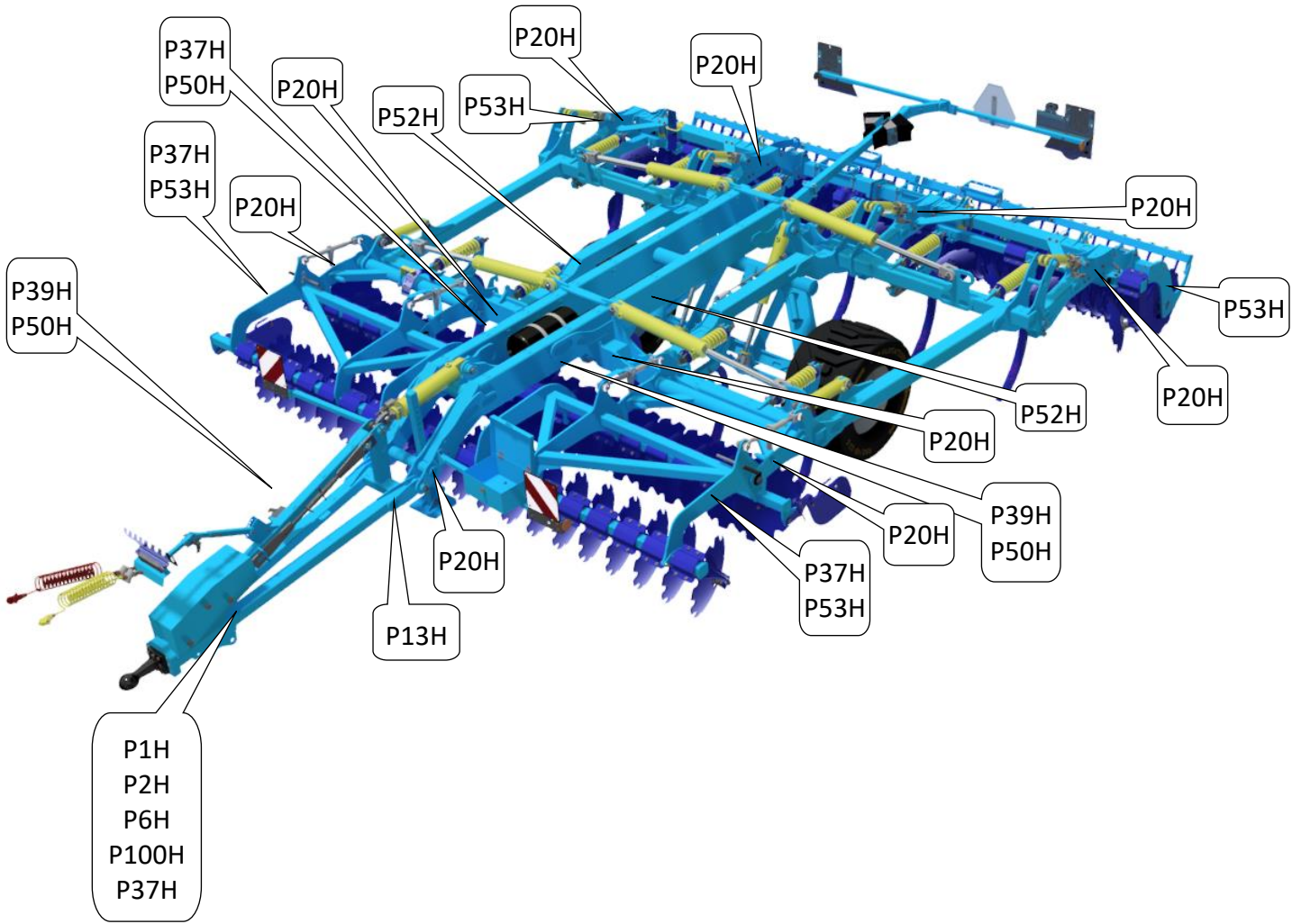
## Basic technological specification of the machine:

- All-area stubble cultivation after harvest with intense mixing effect
- Processing soil up to a depth of 35 cm, tillage replacement
- Excellent incorporation of crop residue into soil

## 1.1 MACHINE SECTION ARRANGEMENT

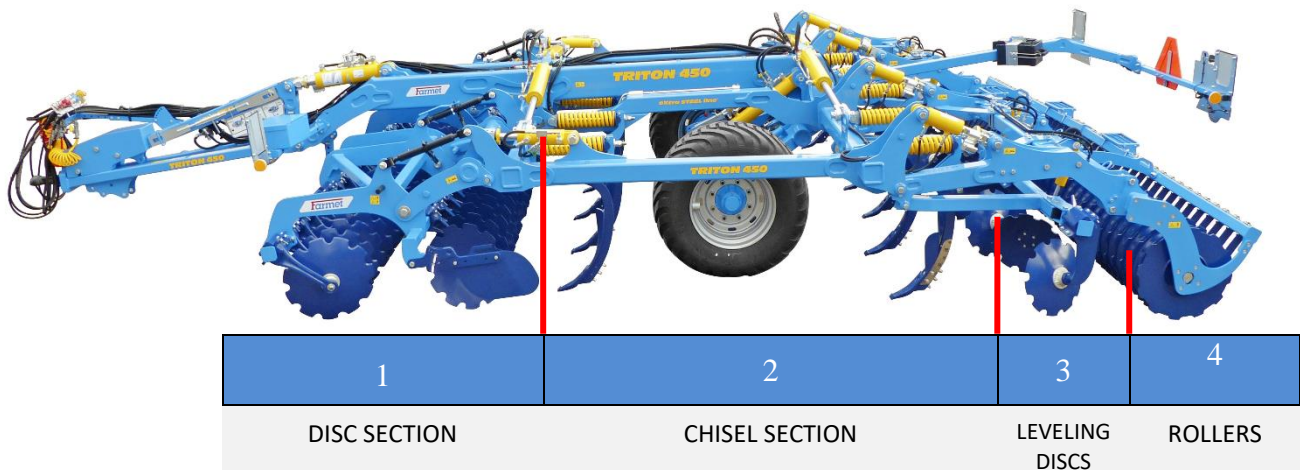

## 1.2 WORK PARTS OF THE MACHINE

### DISC WORKING UNIT

- Disc diameter 560 mm (510 mm)
- Maintenance-free bearing
- Forged tine





## CHISEL WORKING UNIT

- The basic setting of the securing spring (X) is performed by the manufacturer at  $395\pm 5$  mm (15,56 $\pm$ 0,20 in) so it is horizontal.
- Regularly check the nut tightening of the lower and the upper pivot of the securing, tighten as needed.
- Regularly check the nut tightening of the securing rod.

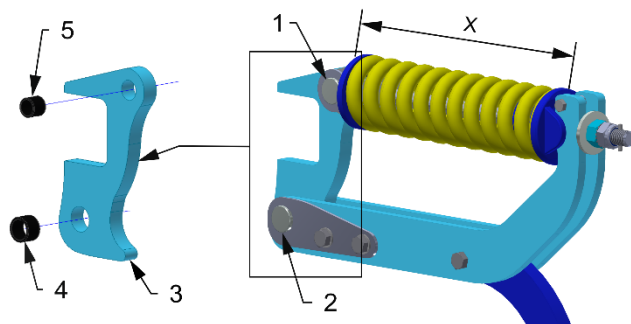

- 1- Upper pivot
- 2- Lower pivot
- 3- Safety back stop
- 4- Lower hardened case
- 5- Upper hardened case

## OFFER OF CHISELS



**Diáto 75 CARBIDE**



**Diáto 75 MULTICARBIDE**



**Diáto 75 MULTICARBIDE PRO**



**Diáto 40 MULTICARBIDE**

## 2 HYDRAULICS

### SUMMARY OF CLOSING (BALL) VALVES

Shut-off (ball) valves are used in the machine: a separate valve for the drawbar piston-rod and a set of valves set up in a combination with the control levers on a well-arranged panel on the drawbar.

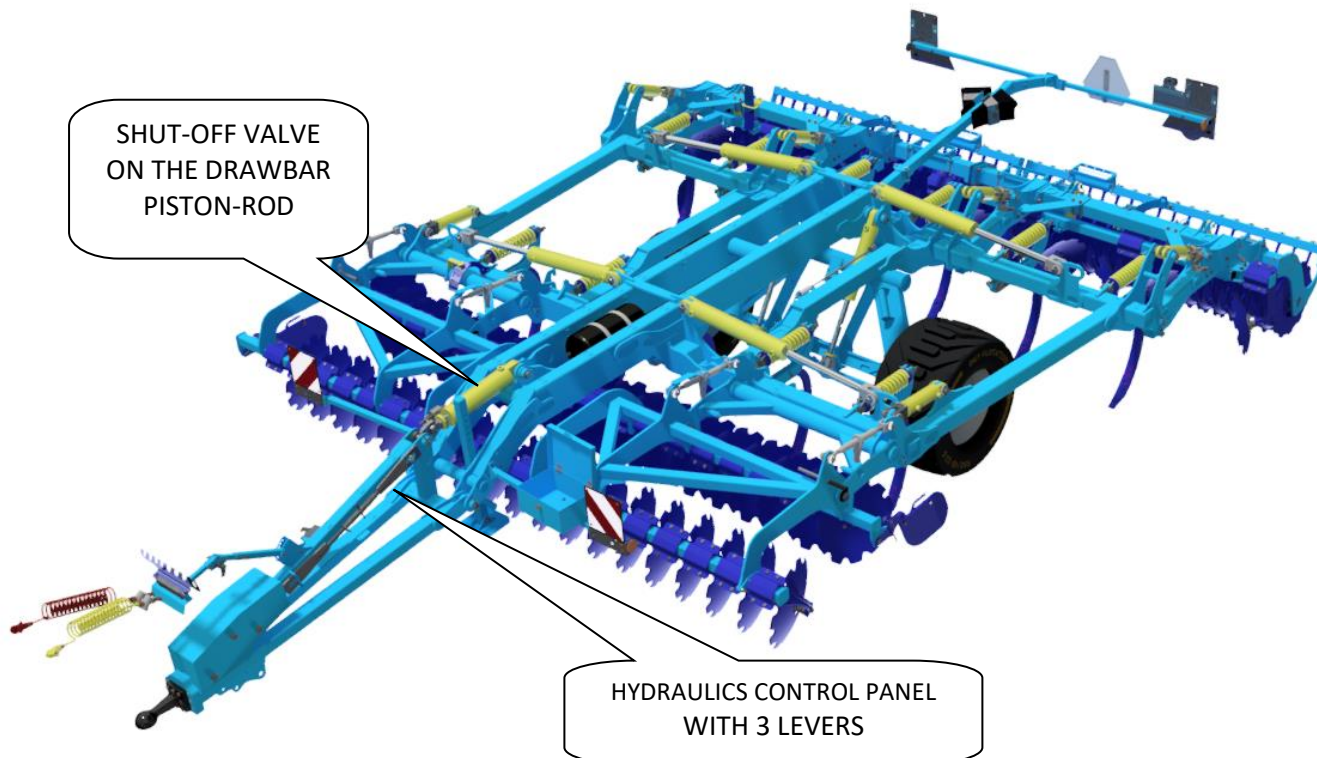

## CLOSING VALVES FOR DRIVING

- For the transport purpose it is necessary to close following ball valves!

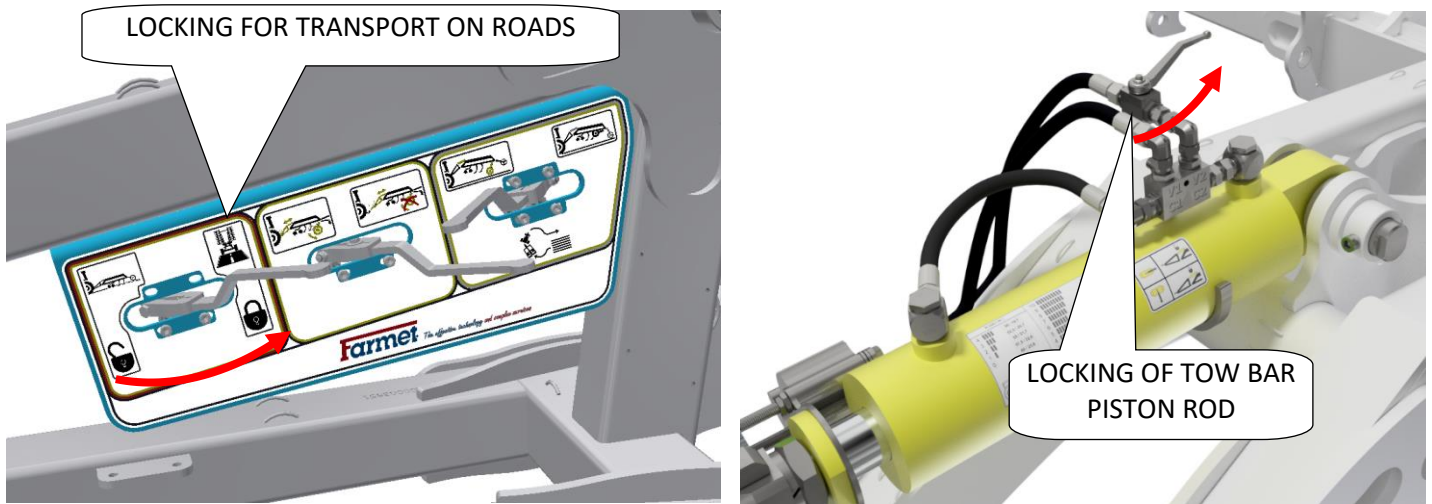

When driving on road it is necessary to keep the machine locking lever in the **RIGHT** position, i.e. locked, and the ball valve of the tow bar piston rod closed, as shown on the label on the machine.

## 2.1 HYDRAULICS OF THE MACHINE

When disconnecting the quick-couplers, both valves on the drawbar must be closed in the same way as for road transportation.

Connect the hydraulics only when the hydraulic circuits of the machine and the tractor (aggregate) are in a pressure-less condition.

The hydraulic system is under high pressure. Regularly check for leaks and immediately remove obvious damage of all lines, hoses, and pipe unions.

When seeking and removing leaks, use only the suitable tools.

For connecting the hydraulic system of the machine to the tractor, use the plug (on the machine) and the socket (on the tractor) of the quick-couplers of the same type. Connect the quick-couplers of the machine to the hydraulic circuits of the tractor so that the **RED DUST CAPS** for folding side frames and for setting the depth of the front levelling discs are on one control circuit, the **YELLOW DUST CAPS** for lifting the machine on the axle are on the second control circuit, the **GREEN DUST CAPS** for setting the front disc section are on the third control circuit, the **BLUE DUST CAPS** for controlling the rear packer discs are on the fourth control circuit, and the **WHITE DUST CAPS** for controlling the setting of the working depth of the machine on the rollers is on the fifth control circuit. In case of optional accessories with hydraulically controlled parking leg, use **BLACK DUST CAPS** for the sixth circuit or when aggregation/shut-down of machine, temporarily connect instead of a circuit of another colour.



In order to prevent accidental or foreign person (children, passengers) caused movement of the hydraulics, the control switchboards on the tractor must be secured or blocked in the transport position.

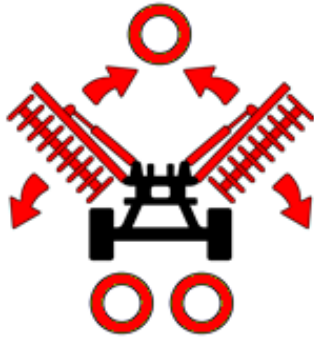

**RED DUST CAPS – controlling the side frame folding**

- 1 STRAP – lifting of side frames up, i.e. putting the machine in transport position. (To fold the machine frames, the machine has to be lifted to the highest position on the axle to switch on the safety valve in the rear of the machine.)
- 2 STRAPS – unfolding of side frames down, i.e. putting the machine in work position.

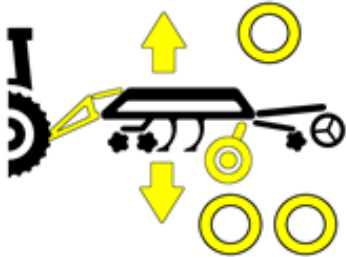

**YELLOW DUST CAPS – controlling the transport axle**

- 1 STRAP - lifting the machine into the transport position, i.e. axle is lowered down
- 2 STRAPS - the machine is lowered to the working position, i.e. the axle is lifted up from the ground .

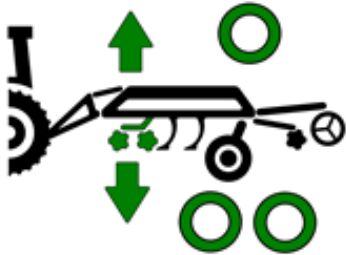

**GREEN DUST CAPS – controlling the position of the front disc section**

- 1 STRAP - lifting the front disc section
- 2 STRAPS - lowering the front disc section

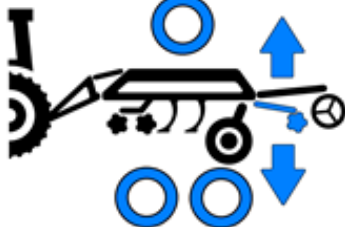

**BLUE DUST CAPS – controlling the position of the rear packer discs**

- 1 STRAP - lifting the packer discs
- 2 STRAPS - recessing the packer discs

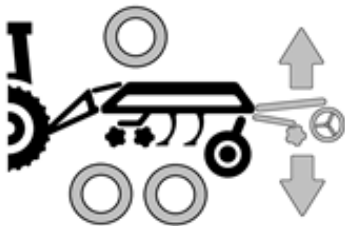

**WHITE DUST CAPS – setting the depth**

- 1 STRAP - lifting the rollers (increasing the working depth)
- 2 STRAPS - lowering the rollers (decreasing the working depth)

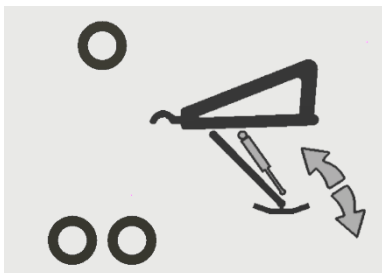

**BLACK DUST CAPS – controlled parking legs (*accessories*)**

- 1 STRAP - lifting of leg
- 2 STRAPS – lowering of leg



Parts of the hydraulic system of the machine, which are under pressure, are forbidden to disassemble. Hydraulic oil that penetrates the skin under high pressure causes severe injuries. In case of injury, seek a physician immediately.

## 2.2 USING THE HYDRAULICS CONTROL PANEL

- There is a control panel with up to 4 levers on the drawbar (the number of levers may differ according to the machine equipment).
- Moving the levers opens or closes the ball valves in the hydraulic circuits.
- The lever positions according to the pictograms below determine the setting of the hydraulic circuits for the required function of the machine.
- The individual levers are also colour-coded for easier orientation of the operator, in accordance with the hydraulic circuits controlled by the corresponding lever.



When driving the machine on road, the lever that locks the machine for transport has to be in the **RIGHT** position, i.e. locked.

### LEVER FOR LOCKING THE MACHINE FOR TRANSPORT

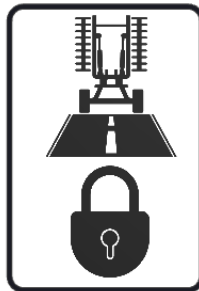
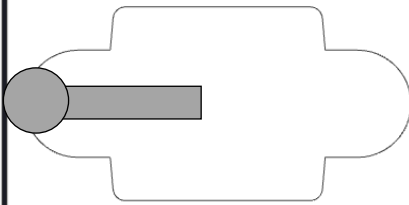
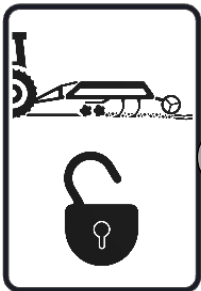

#### LEFT POSITION

The machine is in the working position. The **YELLOW** circuit of the axle and the drawbar piston-rod are open and the piston-rods can move. The **RED** circuit is also open, enabling the lifting and unfolding of side frames.

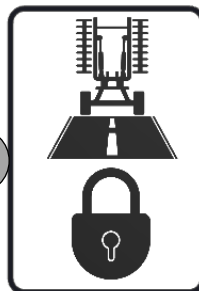
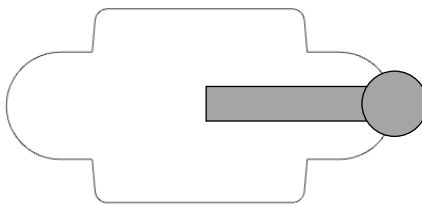
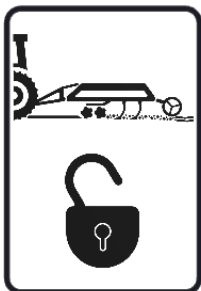

#### RIGHT POSITION

The machine is in the transport position. The **YELLOW** axle circuit and the drawbar piston-rod are closed. The **RED** circuit is closed. Lifting and unfolding of side frames is blocked.

## LEVER FOR SETTING THE MACHINE FOR AGGREGATION

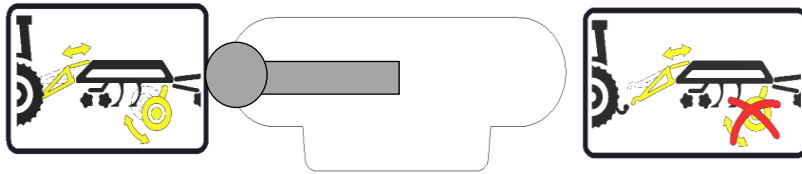

### LEFT POSITION

The **YELLOW** circuit is set in the initial condition, i.e., both the axle and the drawbar piston-rod are controlled at the same time

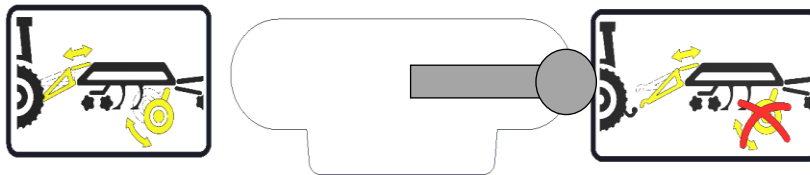

### RIGHT POSITION

The **YELLOW** circuit is set for machine aggregation, i.e., the axle does not move, only the drawbar piston-rod does. The operator is thus able to adjust the height of the hitch as needed during the aggregation of the machine to the pulling vehicle.

## LEVER FOR TURNING AT HEADLAND

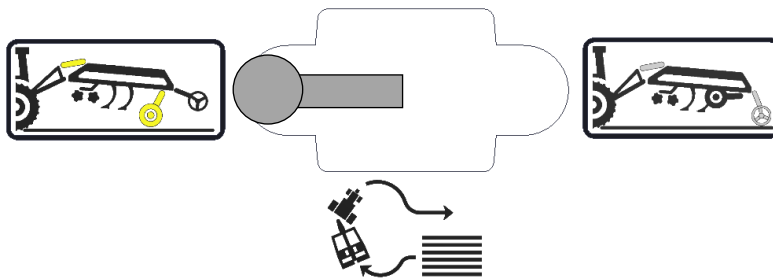

### LEFT POSITION

The machine is set for turning on the transport axle (**YELLOW** circuit). **The drawbar piston-rod is also controlled by the YELLOW circuit when the axle is lifted.**

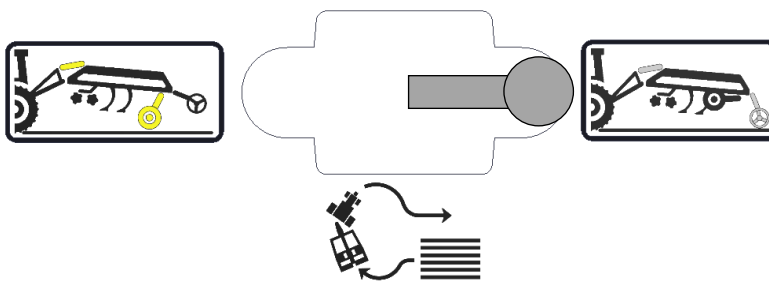

### RIGHT POSITION

The machine is set to turning on the rear roller (**WHITE** circuit). **The drawbar piston-rod is also controlled by the WHITE circuit when the axle is lifted.**



### 2.3 COMPLETE HYDRAULIC SCHEME OF MACHINE

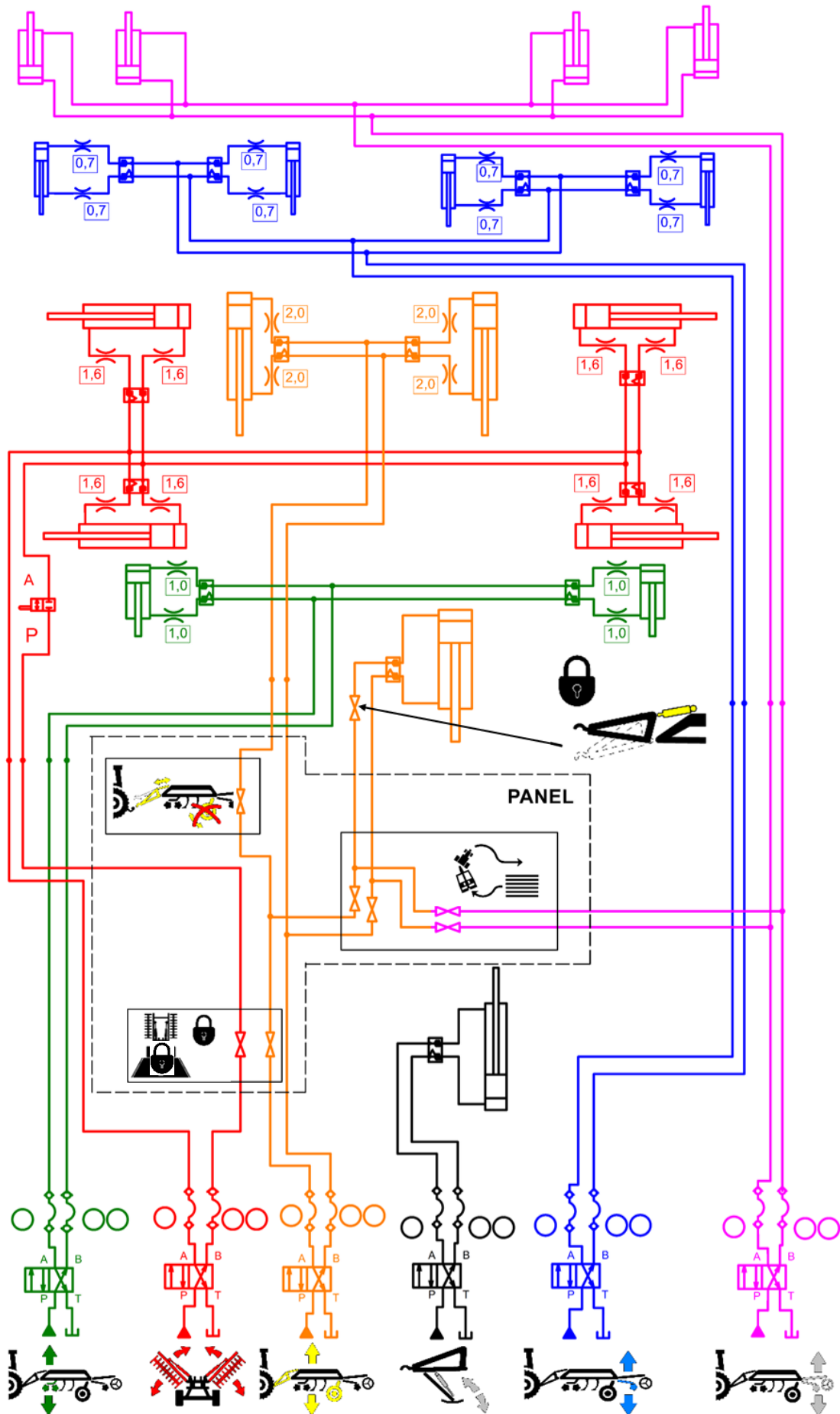

### 3 BRAKE SYSTEM

- The equipment of machine with braking axle contains single-circuit double-hose system made of brake components which activate the braking mechanisms and provides for the pressure air supply from the tractor air system.

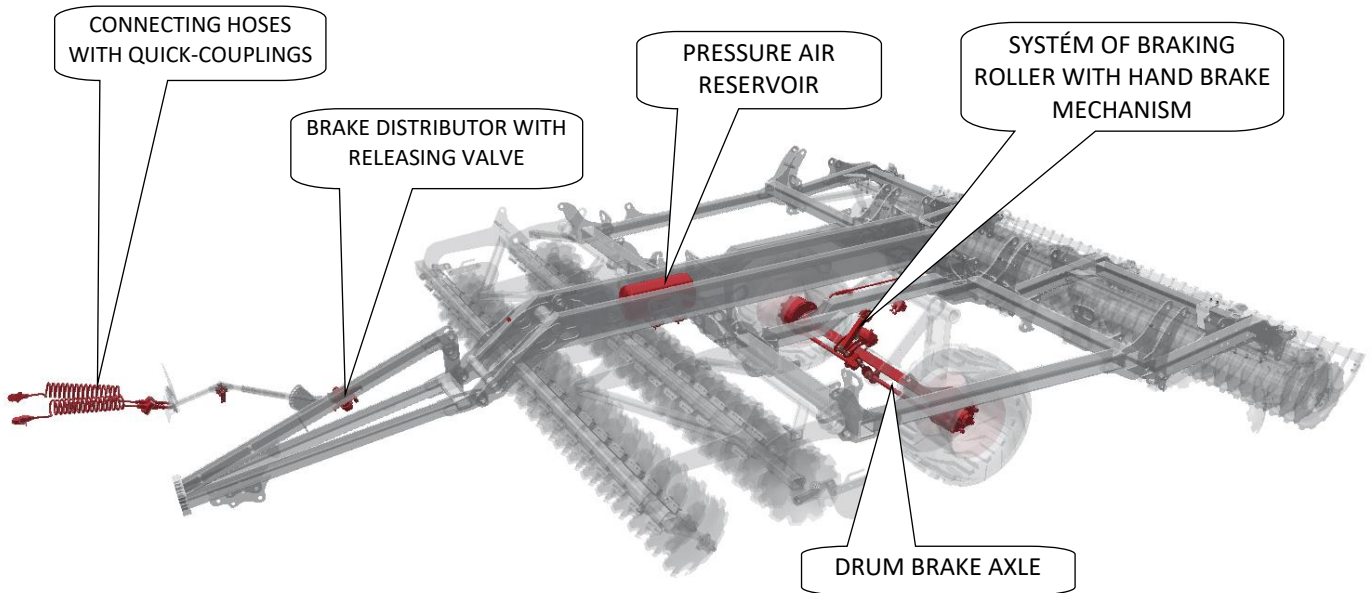

#### 3.1 SERVICE BRAKE

- Connect the system with pressure air sources (tractor) through connecting hoses marked in colours. The **YELLOW** hose marks the brake control circuit. The **RED** hose marks the filling circuit.
- If the hand brake is not activated, the service brake is fully operational immediately after the connection of hoses to the tractor.

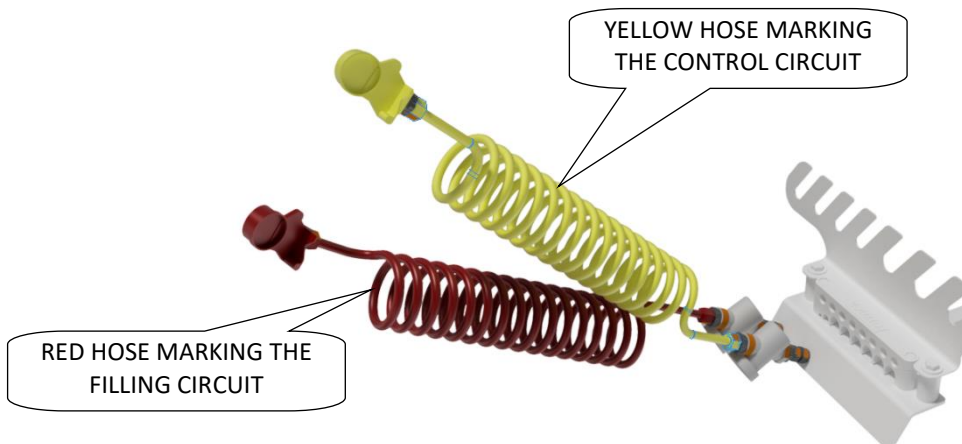

- In order the service brake works correctly, the hand brake needs to be deactivated, i.e. the guiding blocks must allow the movement of braking levers when the braking roller is ejected. The braking roller shall be in its original position – its screw rod needs to be inserted.

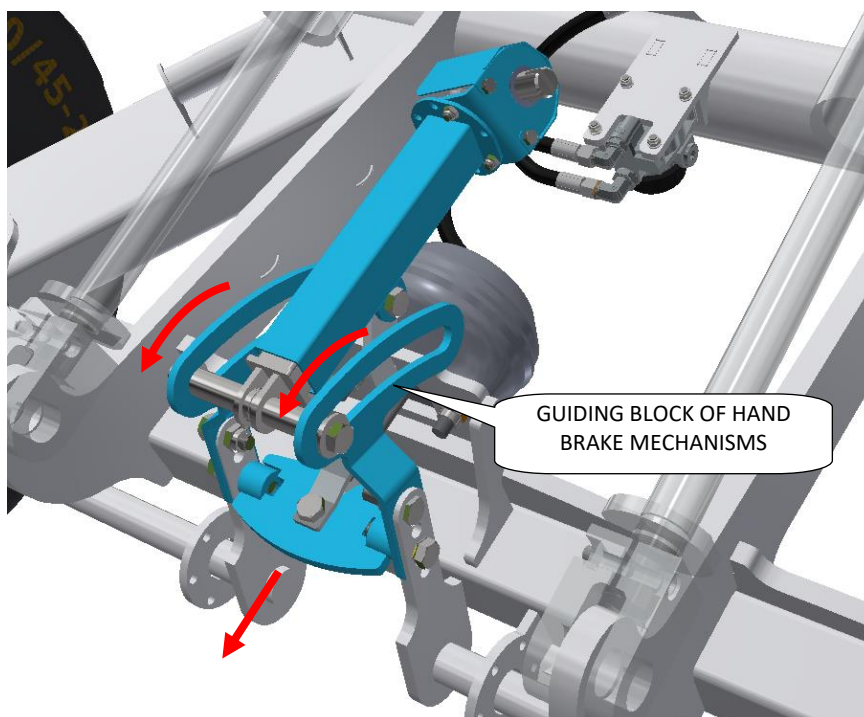

- After having disconnected the brake system from the pressure air source (tractor), the axle brake is set using the air from pressure reservoir. After having released the brake, for ex. in order to handle without the pressure air source in emergency case, use the releasing valve on the brake distributor located on the tow bar.

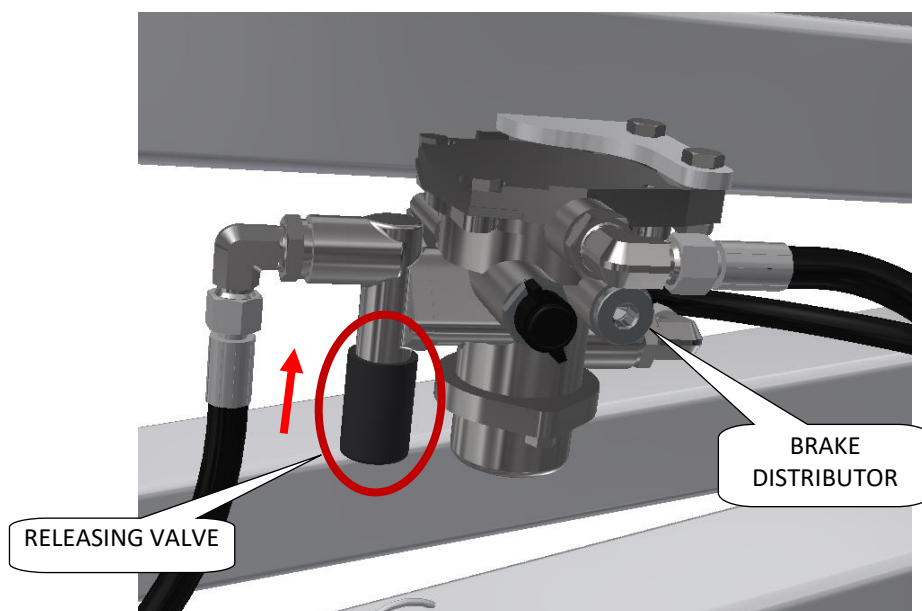

### 3.2 USE OF HAND BRAKE

- Before you disconnect the machine from the tractor, put wedges before wheels and set the manual brake.
- Use the control bar put on the side frame to activate the hand brake.
- Put the control bar on the grooved pin on the hand brake jack and brake the axle by turning.
- Do not enter under the machine structure when activating the hand brake.



**The manual hand brake must be deactivated before driving. Risk of overheating of the brake lining leading to restricted or complete loss of braking effect.**

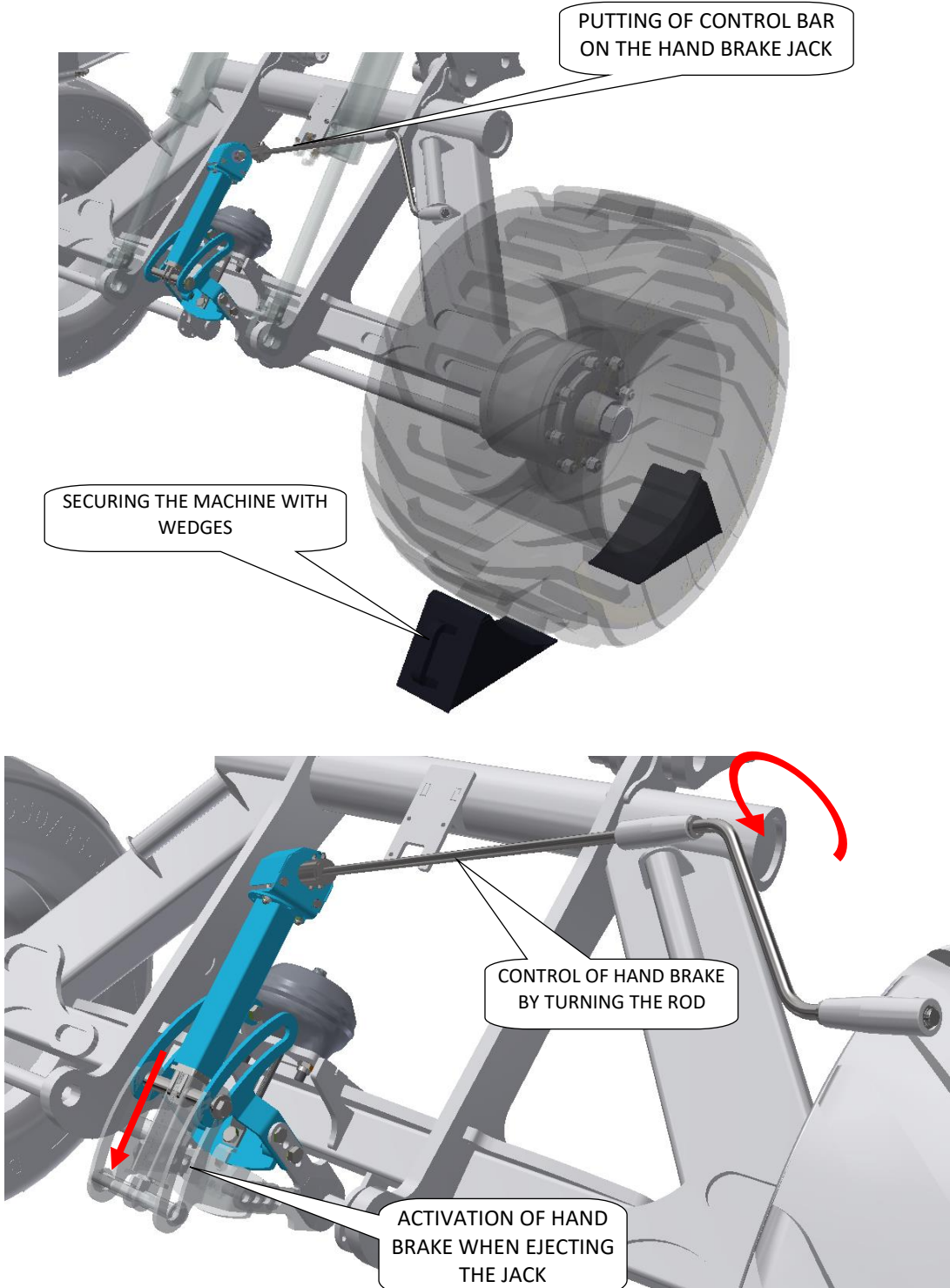

## 4 MACHINE ASSEMBLY AT THE CUSTOMER



- The operator must perform the assembly according to the instructions of the producer, best in cooperation with the expert servicing technician determined by the producer.
- The operator must secure a functional test of all assembled parts after the completion of the machine assembly.
- The operator must secure that the handling of the machine using lifting equipment during its assembly is in accordance with chapter „C“.

## 5 COMMISSIONING



- Before taking over the machine, test and check, whether damage occurred during transport and whether all parts contained in the bill of delivery were supplied.
- Before commissioning the machine, carefully read this operating manual, especially Chapters **A-D**. Before the first use of the machine, familiarise yourselves with its controls and overall function.
- During work with the machine, observe not only the instructions of this operating manual but also generally valid regulations of work safety, health protection, fire and transport safety, and environmental protection.
- The operator must check the machine before every use (commissioning) from the standpoint of completeness, work safety, work hygiene, fire safety, transport safety, and environmental protection. A machine showing signs of damage must not be commissioned.
- Aggregation of the machine with the tractor is to be performed on a flat and hardened surface.
- When working on slopes, observe the lowest slope grade of the set **TRACTOR – MACHINE**.
- Before starting the tractor motor, check whether no person or animal is in the working space of the set and push the warning sound signal.
- The operator is responsible for the safety and all damage caused by the operation of the tractor and the connected machine.
- The operator is obliged to adhere to the technical and safety regulations of the machine determined by the producer when working.
- The operator is obliged to retract the working bodies of the machine from the ground when turning at the headland.
- The operator is obliged to observe the prescribed working depths and speeds stated in the manual in Tabl.2 when working with the machine.
- The operator is obliged to lower the machine to the ground and secure the set against movement before leaving the tractor cabin.

## 6 AGGREGATION TO A TRACTOR

- The machine can be connected only to a tractor, whose curb weight is identical or higher than the overall weight of the connected machine.
- The machine operator must observe all generally valid regulations of work safety, health protection, fire safety, and environmental protection.
- The operator may connect the machine exclusively to a tractor that is equipped with a rear three-point suspension and a functional undamaged hydraulic system.
- It is possible to use the transport axle with the valve on the drawbar piston rod closed to set the height of the drawbar.

The table of requirements for the towing means for work with the machine:

Requirement for the tractor engine power for cultivator <b>TRITON 450 PS</b>		225-350 kW
Requirement for the tractor engine power for cultivator <b>TRITON 600 PS</b>		350-460 kW
Requirement for the bottom hitch	Bottom hitch	C 50 C 70 K 80
Requirement for the tractor's hydraulic system	Side frame folding circuit	Circuit pressure 200 bar, 2 pcs of quick-coupler sockets ISO 12,5
	Depth adjustment circuit	Circuit pressure 200 bar, 2 pcs of quick-coupler sockets ISO 12,5
	Axle lifting circuit	Circuit pressure 200 bar, 2 pcs of quick-coupler sockets ISO 12,5
	Levelling disc circuit	Circuit pressure 200 bar, 2 pcs of quick-coupler sockets ISO 12,5
	Circuit for lifting the front disc section	Circuit pressure 200 bar, 2 pcs of quick-coupler sockets ISO 12,5



**When connecting, no persons may stay in the space between the tractor and the machine.**

### HYDRAULIC OIL SPECIFICATIONS

The hydraulic circuit of the machine is filled with oil at the factory:

Performance level: API GL 5; SAE 10W-30; SAE 80

Manufacturer's specification: ALLISON C4; CATERPILLAR TO-4; VOLVO VCE WB 101; 97303 JONH DEERE 20C/20D ZF TE-ML 03E/05F/06E/06F/06K/17E/21F; PARKER

DENISON HF-0/HF-1/HF-2 New HOLLAND NH 420A/410B MASSEY FERGUSON M1135/M1141/M1143/ M1145 KUBOTA UDT Fluid CASE IH MS-1204/MS-

1206/ MS-1207/MS-1209 FORD M2C134D M2C86B/C CNH MAT 3525/ MAT3526 SPERRY VICKERS/EATON M2950S, I-280-S SAUER

SUNDSTRAND(DANFOSS) Hydro Static Trans fluid; CASE CNH MAT 3540(CVT), Claas(CVT), AGCO CVT; ML200, Valtra G2-10(XT-60+)



## 7 FOLDING AND UNFOLDING OF THE MACHINE



- The hydraulics for the folding and unfolding must be connected to the double-action control unit.
- The operator must ensure that during folding and unfolding of the side frames, no person or animal is within their reach (i.e. at the place of their impact) or vicinity.
- Perform folding and unfolding on flat and solid surfaces or laterally to the slope with the fully open control unit.
- Folding and unfolding may only be performed when the machine is lifted on the axle. The folding circuit is hydraulically blocked in any transport axle position other than its maximum extension.
- Remove stuck soil from folding points, soil may impair function and cause damage to the mechanics.
- During folding or unfolding, check the side frames and have them continuously fold into the end position to the stoppers.



**Attention!!! The machine must be lifted on the axle prior to folding and when folded!!!**

**When the machine is not lifted on the axle in its maximum position, the folding circuit is hydraulically block and the machine cannot be folded, only unfolded.**

## 8 MACHINE TRANSPORT ON ROADS

### Transport position of **TRITON 450 PS** | **TRITON 600 PS**

- Connect the machine by attaching it to the tractor.
- Lift the machine on the axle, switch the ball valve of the axle to the closed position.
- Fold the side frames to the transport position, switch the ball valve to the closed position.
- Install the transport rod between the side frames (see the picture).
- Tighten the centre piece on the rod by screwing and secure with locking nut.
- The machine must be equipped with removable shields with marking of contours, functional lighting, and the board of the rear marking for slow vehicles (according to ECE No. 69).
- The lighting must be activated during travelling on roads.
- The tractor must be equipped with a special light device of an orange colour, which must be activated during travelling on roads.
- The maximum transport speed during travelling on roads is **30 kph**.

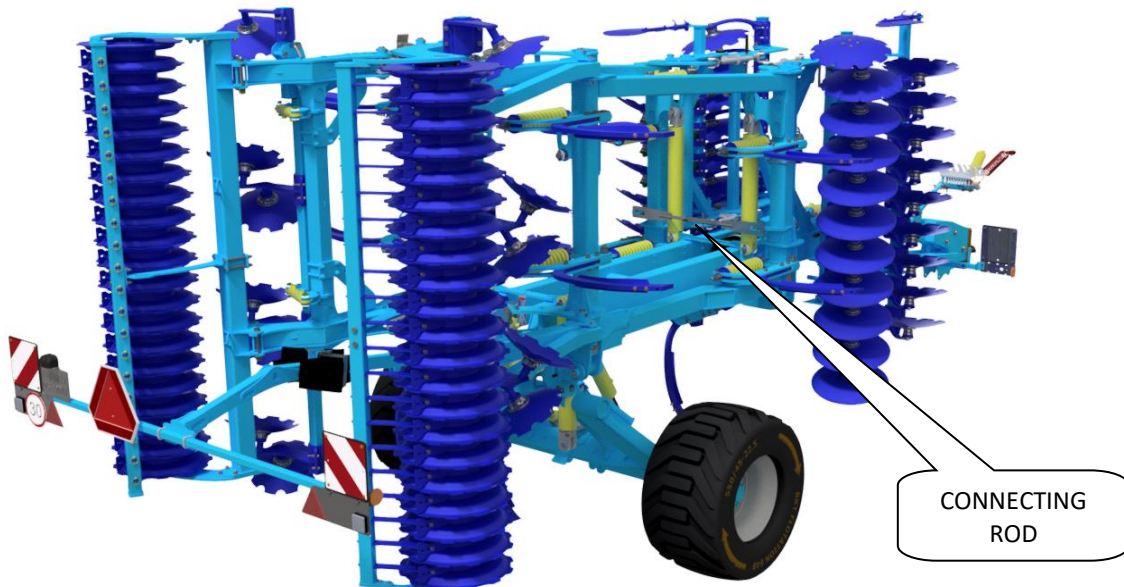

**Transportation is only permitted when the connecting rod has been properly installed and secured!**

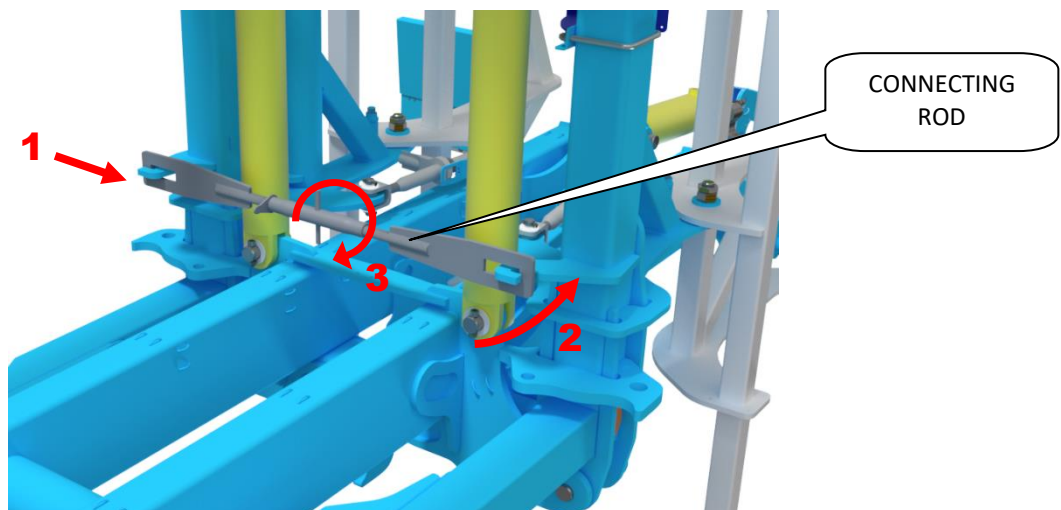

## **CHECKING THE NUTS ON THE TRANSPORT AXLE**

- Use the plastic arrow “Check Point” to check for loose nuts. It promptly shows the condition of the nuts, whether they are loose or not.
- Always check the Check Points before driving.
- When the arrows are not facing one another, the nuts have to be tightened to the required torque and the Check Point arrows have to point against one another as shown in the green picture.

### **Torque for the axle nuts:**

M18x1,5 - 265Nm

M20x1,5 - 343Nm

M22x1,5 - 440Nm

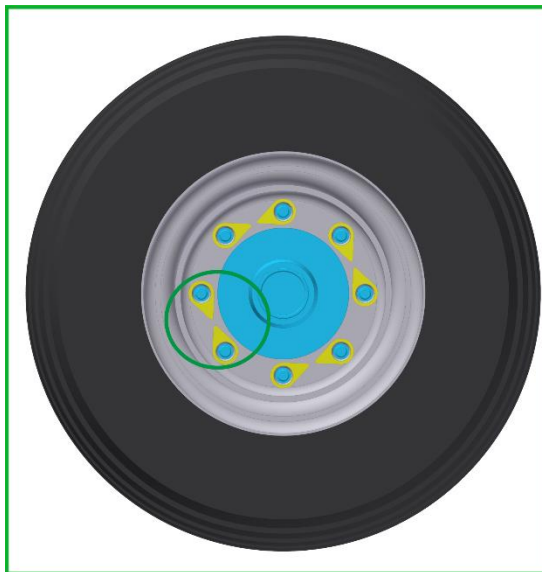

**INITIAL POINT-TO-POINT CONFIGURATION**

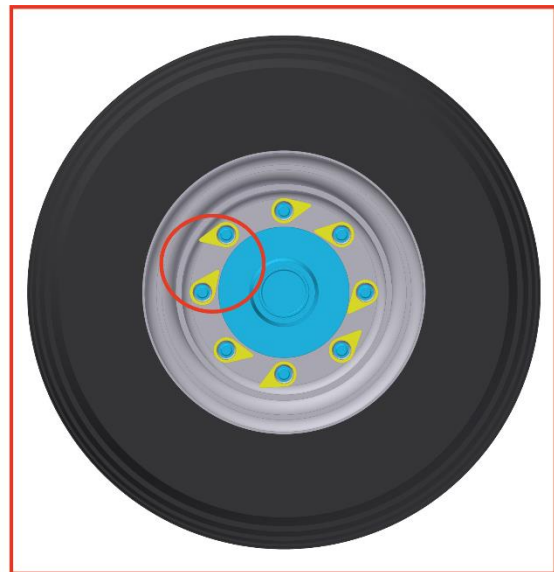

**DANGER – WHEEL NUTS HAVE LOOSENED!**

- Bring the machine into the transport position.
- The operator is obliged to pay increased attention during transport on roads, due to the transport dimensions of the machine.
- The operator must observe the valid regulations for transport on roads (laws, decrees) after connecting the machine to the tractor, for reason of a change of the axle load. The driving properties of the set also change depending on the terrain nature, adapt the manner of driving to these conditions.
- The operator is obliged to present the machine certificate of roadworthiness as needed, according to the valid regulations for road traffic (decree, law) (only in the Czech Republic).
- The operator is obliged to secure sufficient outlook during reversing from his position of the tractor driver. In case of insufficient outlook, the operator is obliged to call a competent and informed person.
- The operator must fold the side frames for transport and secure them against unwanted unfolding by disconnecting the hydraulic circuit of the machine and the tractor.
- During machine transport on roads, the operator must observe the valid laws and decrees that deal with this topic and which specify the relationships of the tractor axle load depending on transport speed.

## 8.1 SHARP MACHINE PROJECTION



- The machine contains sharp structural projections
- **It is prohibited to operate and transport the machine on roads when visibility is reduced!!** - Persons or objects, or other road traffic participants could get caught.
- **The machine operator must be extra cautious when driving on roads and consider the width of the machine and safe distance from persons, vehicles and objects, or other road traffic participants!!**

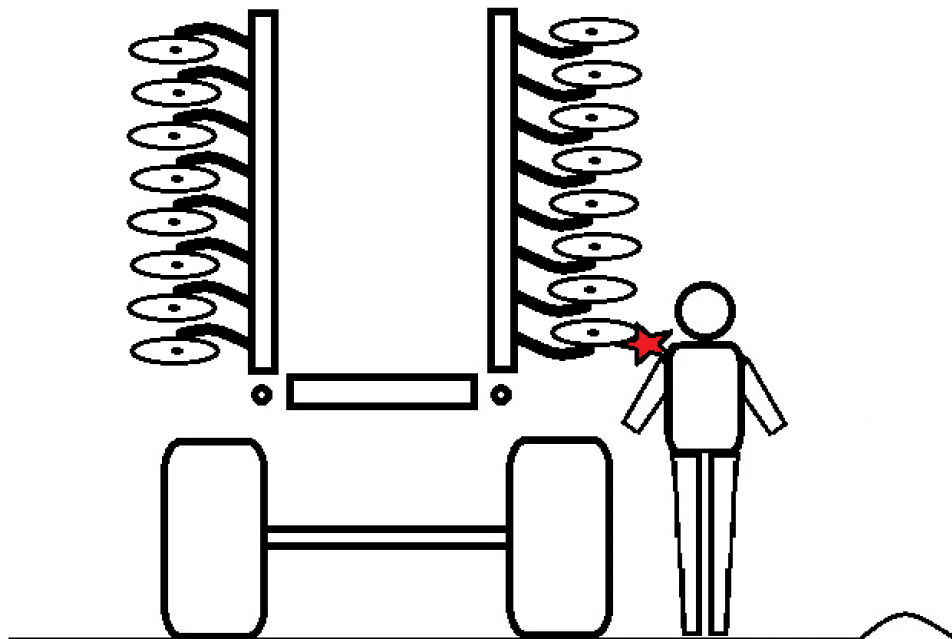
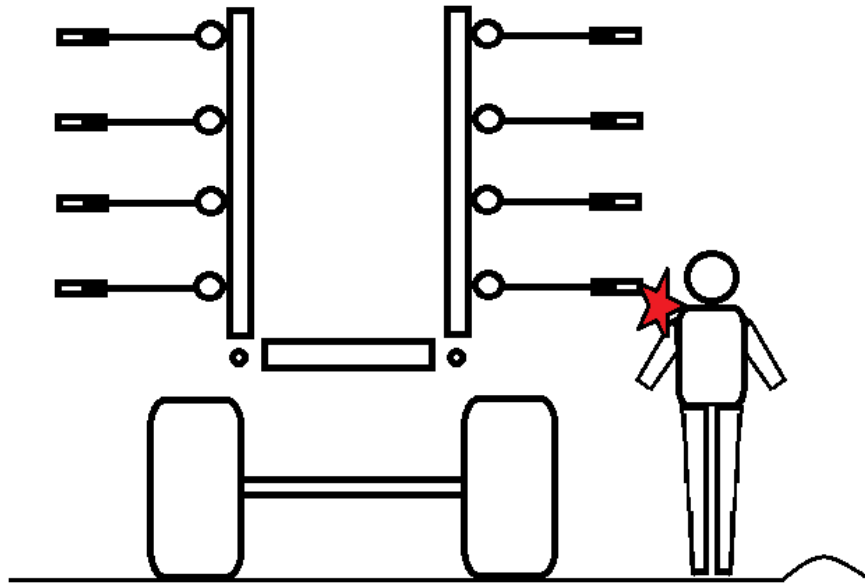

## 9 MACHINE ADJUSTMENT

### 9.1 WORKING DEPTH ADJUSTMENT

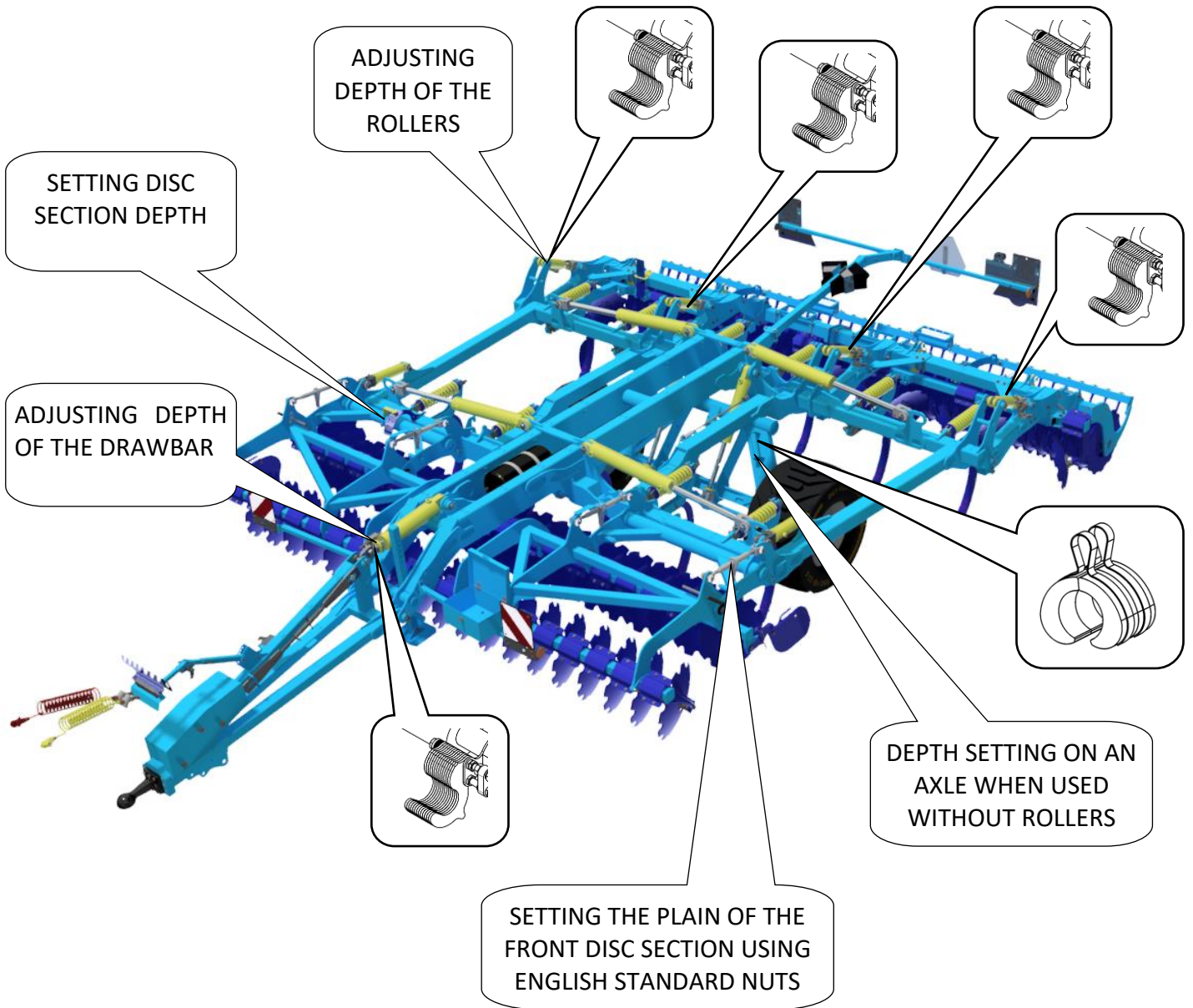



















## SETTING THE WORKING DEPTH OF THE CHISELS

- The working depth of the chisels is set by adjusting the machine frame height above the ground.
- In the front of the machine, the depth is set on the drawbar.
- In the rear of the machine, the depth is set on the supporting roller.
- The machine frame must be parallel to the ground.
- The adjustment is done by changing the number of the space washers on the piston-rods.
- The table states the individual working positions and the number of space washers needed to achieve the required machine depth.
- The stated working depths of the individual positions are for information only. They might differ according to the individual soil conditions. It is possible to add or remove a required number of space washers as needed.



- The working depth of the machine must be set so that the spring protection of the working tools (tines) does not unlock frequently. The spring protection should only release very sporadically. Unlocking can occur on a maximum of one working tool (tine) on the entire machine after a 100 - 200 m drive. If unlocking is more frequent, it is necessary to reduce the working depth or use narrow chisels. Due to the frequent release of the spring protection, excessive wear of the pins and other parts of the spring protection can occur. In this case, their more frequent replacement is necessary.

**The number of the space washers must be the same on all piston-rods!!!**















17		2 / 0,8
16		4 / 1,6
15		6 / 2,4
14		8 / 3,1
13		10 / 3,9
12		12 / 4,7
11		14 / 5,5
10		16 / 6,1
9		18 / 6,9
8		20 / 7,7
7		22 / 8,5
6		24 / 9,3
5		25 / 9,8
4		27 / 10,6
3		29 / 11,4
2		31 / 12,2
1		33 / 13,0
0		35 / 13,8





## ADJUSTMENT THE DRAWBAR PISTON ACCORDING TO THE TRACTOR HITCH

- The number of space washers on the drawbar piston-rod must be adjusted according to the height of the tractor hitch above the ground.
- The number of space washers must be increased by the number stated in the left part of following table.
- The number of space washer can be adjusted, regardless the table, to obtain the parallel position of the frame with the ground.

h [cm / in ]				
4	50 / 19,7	13		2,5 / 1,0
3	52,5 / 20,7	12		5 / 2,0
2	55 / 21,7	11		7,5 / 3,0
1	57,5 / 22,6	10		10 / 3,9
0	60 / 23,6	9		12,5 / 4,9
		8		15 / 5,9
		7		17,5 / 6,9
		6		20 / 7,9
		5		22,5 / 8,9
		4		25 / 9,8
		3		27,5 / 10,8
		2		30 / 11,8
		1		32,5 / 12,8
		0		35 / 13,8

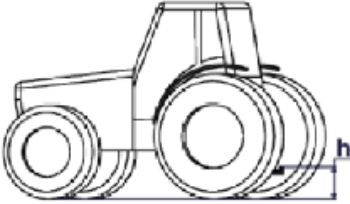
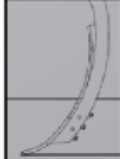
### Examples:

The tractor tow height is 60 cm above the ground and we wish to work with chisel depth 20 cm:

1. Set 8 space washers in all roller piston rods.
2. Set only 6 space washers in the tow bar piston rod (as per the right side of the table) as it is not necessary to add any space washer for the tow being 60 cm above the ground (see the left part of the table).

The tractor tow height is 50 cm above the ground and we wish to work with chisel depth 15 cm:

1. Set 10 space washers in all roller piston rods.
2. Set 4 space washers in the tow bar piston rod in order to compensate the lower tow (see the left side of the table for the tow bar piston rod) and another 8 space washers (right side of the table for the tow bar piston rod).

## SETTING THE WORKING DEPTH OF THE FRONT DISC SECTION

- The working depth of the disc section depends on the set depth of the chisels.
- The setting range for the front disc section is 330 mm so that it is possible to cover the range of the working depth of the discs from 50 to 120 mm for all the working depths of the chisel section.
- The working depth difference between the disc and chisel sections is set hydraulically from the tractor cabin using the **GREEN** circuit.
- The position of the disc section can be seen on the indicator with number 1-3.
- The indicator position can be adjusted by turning the strap with the scale.

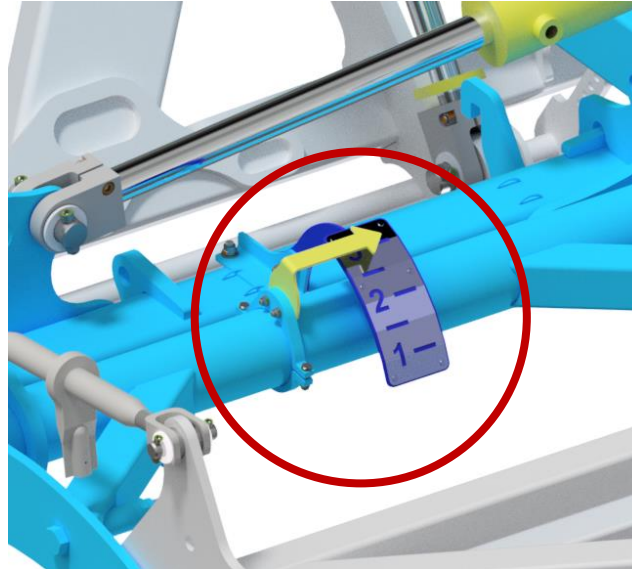

## SETTING OF DISC SECTION TO BE IN PARALLEL WITH THE GROUND

- Perform the setting using ratchet nuts with removable control lever.
- The setting does not change when the working depth changes.
- The English standard nuts have to be set evenly, the length of all nuts has to be identical for operation.
- The section is parallel to the ground when the length of the English standard nut is  $L = 550$  mm.

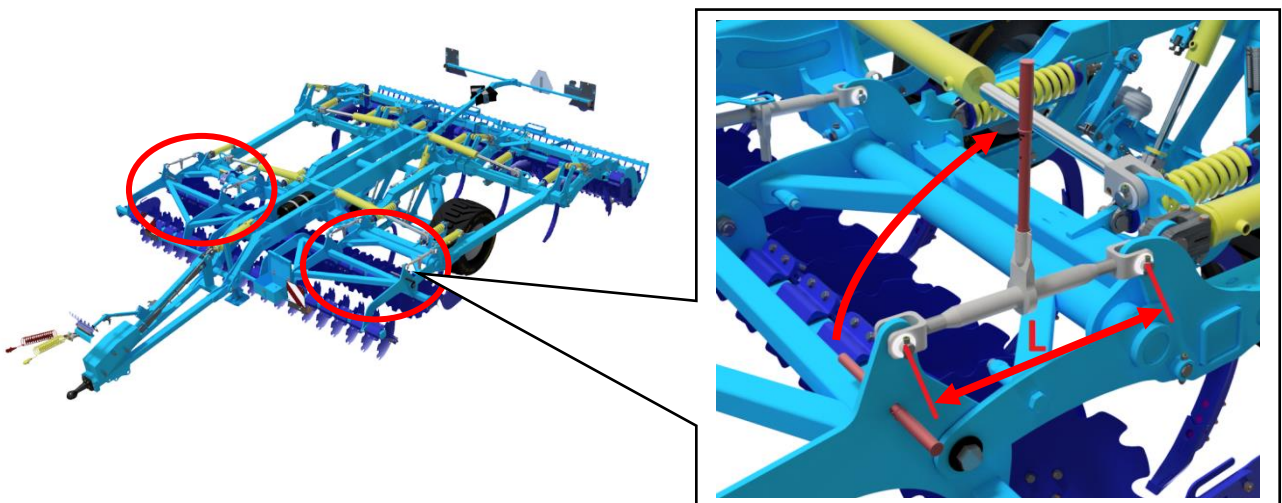

## 9.2 ADJUSTING THE LEVELLING DISCS

- The depth of the levelling discs is set using the hydraulic circuit (BLUE). Be careful when performing the adjustment.
- The height setting of the levelling discs can be checked on the indicator with number 1-3 as shown in the picture:

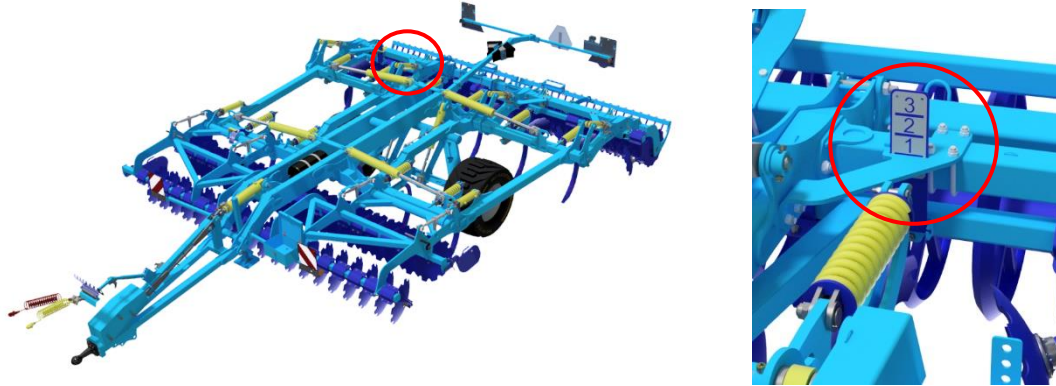

Correctly set discs provide perfect levelling and covering with fine soil along the entire width. When the discs are recessed too low, there are grooves behind the rear shares; when the discs are recessed too deep, there are tracks of collected soil behind the machine. Check the correct disc setting during work – the setting may differ according to the soil conditions and the wear of the discs.

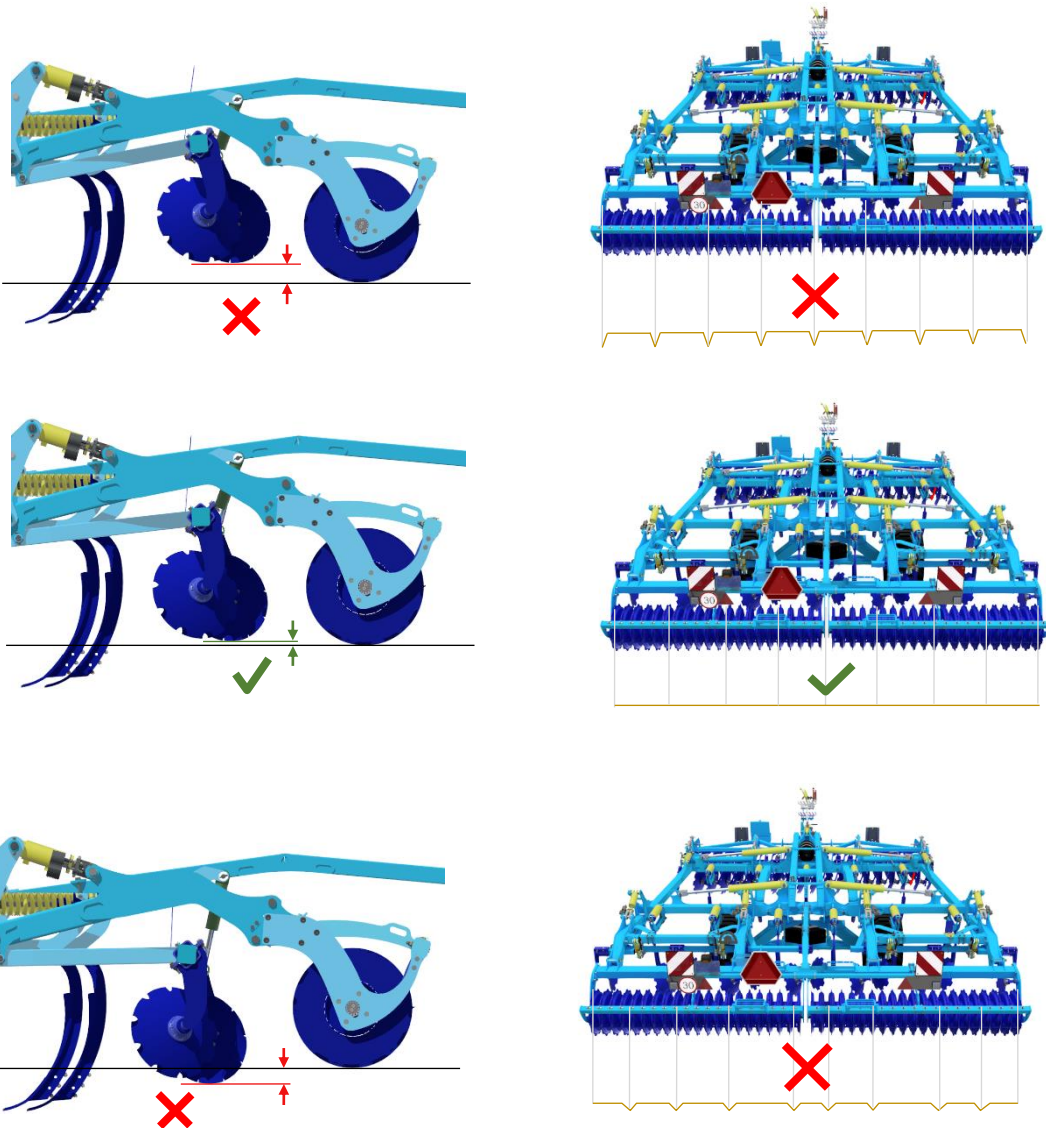

- With the securing pin removed the edge discs can be ejected to another 2 positions.
- Eject the discs to the necessary position pursuant to the loosened soil character to obtain good processing of soil band edges.
- Secure the ejected disc with the pin and split pin to avoid undesirable releasing of the disc during the work on the field.
- Before tilting the machine, insert the edge discs in their shortest position. Only this way with transport height stated in table 2/p.4 is secured.

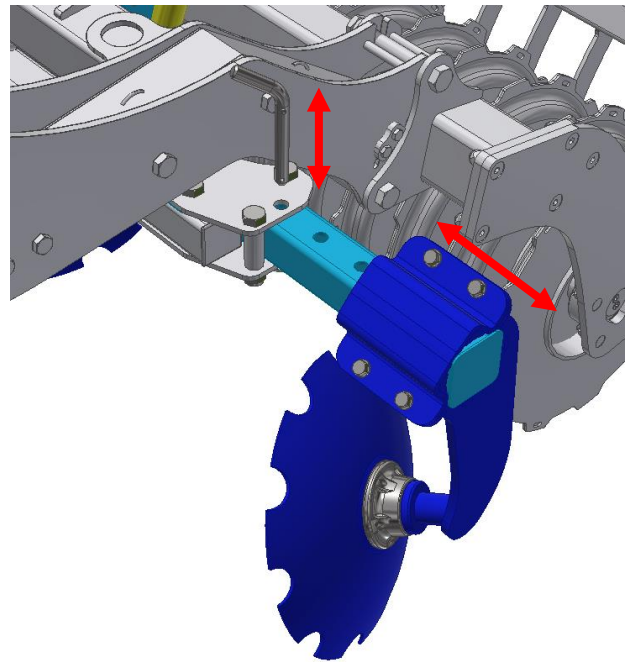
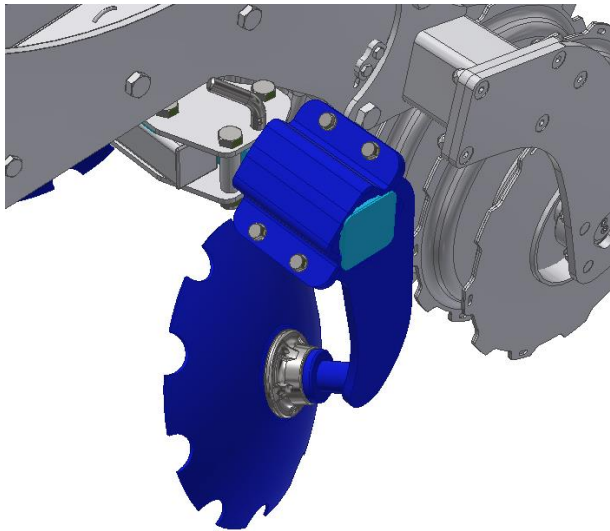



### 9.3 WORKING DEPTH SETTING WHEN WORKING WITHOUT ROLLERS

- The machines **TRITON** are also designed to be used with fully dismantled rear roller.
- Individual rollers are always fixed with a pair of screws to the supporting frame. In order to dismantle individual rollers no further screw joints need to be released.

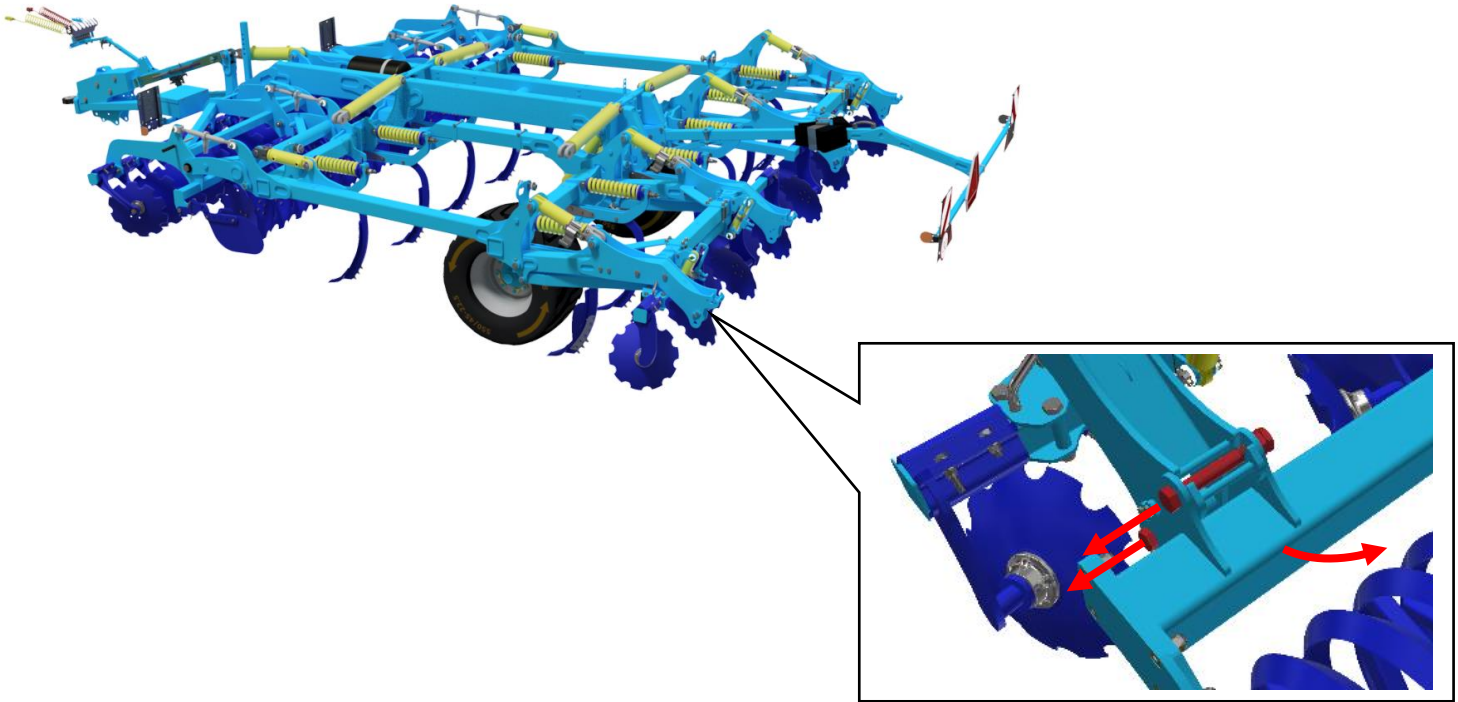



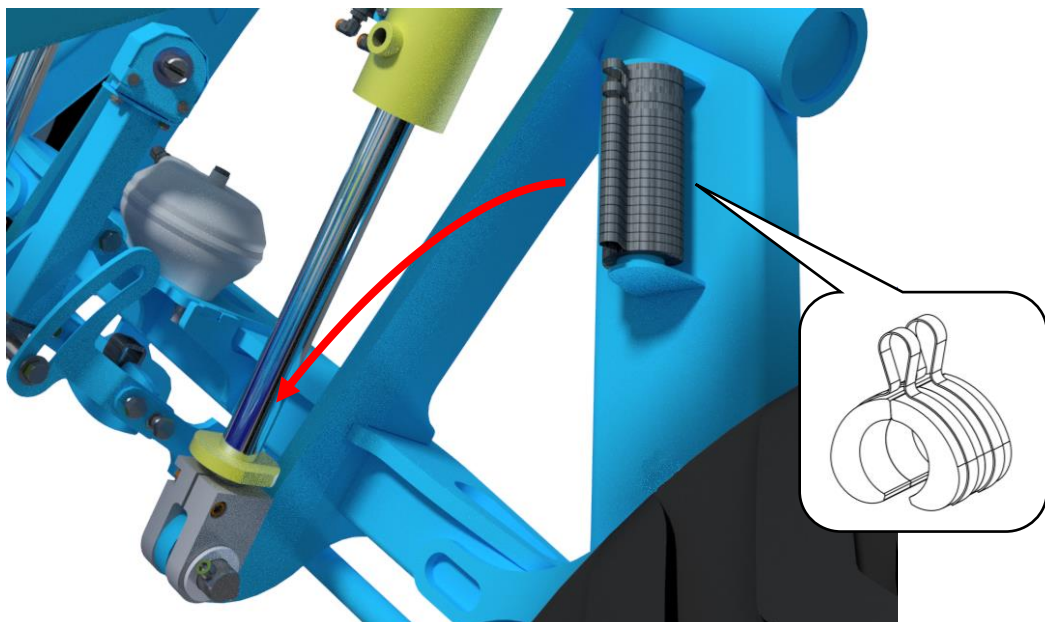













- In case the machine works without rear rollers, the transport axle is used as a supporting element.
- Setting of the axle height defines also the value of processed depth.
- The same principles for setting of supporting roller are valid for setting of working depth.
- The machine frame needs to be always in parallel to the ground.
- Setting is made by changing the number of used brackets on piston rods of transport axle.





- The table shows individual working depths and the number of brackets needed to achieve the requested machine depth.
- When setting the depth on the transport axle it is also necessary to set the corresponding number of space washers on the tow bar piston rod based on the chosen working depth.
- Mentioned working depths of individual positions are only indicative. They can vary depending on specific soil conditions. If necessary, add or remove the necessary number of brackets.

**The same number of brackets must always be on both piston rods of transport axle!!!**

16		3 / 1,2
15		5 / 2,0
14		7 / 2,8
13		9 / 3,5
12		11 / 4,3
11		13 / 5,1
10		15 / 5,9
9		17 / 6,7
8		19 / 7,5
7		21 / 8,3
6		23 / 9,1
5		25 / 9,8
4		27 / 10,6
3		29 / 11,4
2		31 / 12,2
1		33 / 13,0
0		35 / 13,8

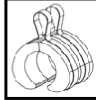
[ cm / in ]

Example:

The tractor has the tow height 60 cm above the ground and we wish to work in chisel depth 20 cm:

1. Fix 2 large brackets (width 25,4 mm) on both piston rods of axle and further 7 smaller brackets (width 9,53 mm).
2. On the tow bar piston rod set only 6 space washers as for the tow 60 cm above the ground no further space washers need to be added (see the table p. 31).

The tractor has the tow height 50 cm above the ground and we wish to work in chisel depth 15 cm:

1. Fix 2 large brackets (width 25,4 mm) on both piston rods of axle and further 10 smaller brackets (width 9,53 mm).
2. On the tow bar piston rod set 4 space washers to compensate the lower tow and further 8 space washers (see the table p. 31).



## 10 MACHINE MAINTENANCE AND REPAIR



**Observe the safety instructions for treatment and maintenance.**



- If it is necessary to weld during the repair and have the machine connected to the tractor, it must have disconnected supply cables from the alternator and the accumulator.
- Check the tightening of all screw and other assembly connections at the machine before every use of the machine, furthermore continuously as needed.
- Continuously check the wear of the working bodies of the machine, possibly replace these worn working bodies with new ones.
- Adjustment, cleaning, and lubrication of the machine may only be performed with the machine at rest (i.e. the machine is standing and not working).
- When working on a lifted machine, use suitable support equipment supported at marked points or at points suitable for that.
- During adjustment, cleaning, maintenance, and repair of the machine, you must secure those parts of the machine that could endanger the operator by falling or another movement.
- For catching the machine during handling using lifting equipment, use only the places marked with self-adhesive labels with the chain sign "".
- Upon a failure or damage of the machine, immediately turn off the tractor's engine and secure against restarting, secure the machine against movement ⇒ only then you can remove the failure.
- During repairs of the machine, use exclusively the genuine spare parts, suitable tools and protective equipment.
- Regularly check the prescribed pressure in the machine tyres and the condition of the tyres. Perform possible repairs of the tyres in an expert workshop.
- **Check the indicator of loose nuts, "Check Point", regularly according to the instructions.**
- Keep the machine clean.



**Do not clean hydraulic cylinders and bearings with a high-pressure cleaner or direct water stream. The seals and bearings are not watertight at high pressure.**

## MAINTENANCE PLAN

Perform the planned maintenance according to the instructions:

Maintenance Task	Daily (season)	Once a week	Before season	After season	Time interval
<b>Machine in general</b>					
<ul style="list-style-type: none"> <li>Visual inspection of the machine</li> <li>Checking for any undesirable sounds, vibrations and excessive wear</li> </ul>	X				
<ul style="list-style-type: none"> <li>Checking crucial nodes: pins, bearings, rollers, working parts</li> </ul>	X		X	X	
<ul style="list-style-type: none"> <li>Machine cleaning</li> <li>Storing the machine under roof, if possible</li> <li>Recording the mileage of the machine/season (ha)</li> </ul>		X		X	
<ul style="list-style-type: none"> <li>Comprehensive inspection</li> <li>Checking the frame</li> </ul>	X			X	
<div style="display: flex; align-items: center;">  <p>Do not use a high-pressure cleaner or direct stream of water to clean the hydraulic rollers, bearings, electric and electronic parts. The seals and bearings are not waterproof at high pressure.</p> </div>					
<b>Hydraulic system</b>					
Checking the function, tightness, mounting and worn spots of all hydraulic parts and hoses		X	X		
<b>Hydraulic hoses – replacement:</b> <ul style="list-style-type: none"> <li>Damaged external casing of the hose (mechanically or blistered)</li> <li>Fluid seepage (especially the end piece)</li> <li>Bumps or blisters on the hose</li> <li>Deformed or corroded end piece</li> <li>Loose end piece – the hose spins</li> </ul>	X			X	
Hydraulic hoses - replacement: <ul style="list-style-type: none"> <li>Expired service life of the hose</li> </ul> <div style="display: flex; justify-content: space-around; margin-top: 10px;">   </div>					6 years
<p><b>!!! PREVENTION means removing the problem according to the plan, outside the season, without stress and comfortably before a secondary problem, an accident or a health hazard arises.</b></p>					

## MAINTENANCE PLAN

Perform the planned maintenance according to the instructions:

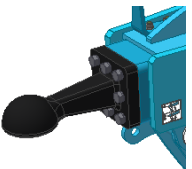
Maintenance Task	Daily (season)	Once a week	Before season	After season	Time interval						
<b>Bolt connections</b>											
<b>Visual</b> inspection of bolt and hydraulic joints, tighten any loose joints using a corresponding torque (see the torque chart)	X			X							
<b>Towing lug</b> – check, tighten if needed <table border="1" style="margin-left: 20px; margin-top: 10px;"> <tr> <td>M16 - 10.9.</td> <td>300 Nm</td> </tr> <tr> <td>M20 - 10.9.</td> <td>560 Nm</td> </tr> </table> 	M16 - 10.9.	300 Nm	M20 - 10.9.	560 Nm		X	X				
M16 - 10.9.	300 Nm										
M20 - 10.9.	560 Nm										
<b>Wheels – tighten all wheel nuts.</b> <ul style="list-style-type: none"> <li>• <b>First time: after 10 hours of operation</b></li> <li>• <b>Wheel replacement: after 10 hours of operation</b></li> </ul> <table border="1" style="margin-left: 20px; margin-top: 10px;"> <tr> <td>M 18 x 1.5</td> <td>300 Nm</td> </tr> <tr> <td>M 20 x 1.5</td> <td>400 Nm</td> </tr> <tr> <td>M 22 x 1.5</td> <td>500 Nm</td> </tr> </table>	M 18 x 1.5	300 Nm	M 20 x 1.5	400 Nm	M 22 x 1.5	500 Nm		X	X		
M 18 x 1.5	300 Nm										
M 20 x 1.5	400 Nm										
M 22 x 1.5	500 Nm										
<b>Brake system</b>											
<b>Brake line and hoses</b> – check the function, tightness, mounting and clamping, or breaking	X		X	X							
<b>Brake components</b> – check the function, tightness, mounting	X		X	X							
<b>Air nozzle</b> – drain using the draining valve		X		X							
<b>Draining valve</b> – check the function, clean and replace sealing			X	X							
<b>Pipe filter</b> – clean			X	X							
<b>Brake/parking brake</b> – check the function, escapement setting <b>25-45mm</b>	X										
<b>Brake lining</b> – check the condition of the brake lining, min. thickness of 3mm				X							
<b>Wheels/axle</b>											
<b>Checking the tyre pressure</b>											
Transport axle	TRITON 450 PS TRITON 600 PS	550/45-22,5 pressure 480kPa	X		X						
<b>Transport axle bearings</b> – check and adjust allowance if needed (in the workshop)				X							

## MAINTENANCE PLAN

Perform the planned maintenance according to the instructions:

Maintenance Task	Daily (season)	Once a week	Before season	After season	Time interval
<b>Electric cables</b>					
Check for any damage, replace if needed		X	X		
<b>Safety measures</b>					
<b>Lighting and safety hatched boards</b> – check the condition, function and cleanliness	X		X		
<b>Hazard and safety labels</b> – check that they are installed and legible		X			
<b>Machine lubrication plan</b>					
<b>Drawbar joint / lifting loop</b> – grease	X			X	
<b>Handbrake bolt</b> – grease or suitable oil	X			X	
<b>Axle bearings</b> – grease with Lithium content – check, refill if needed				X	
<b>After season</b>					
<b>Entire machine</b> <ul style="list-style-type: none"> <li>• Treat and clean the machine; do not spray oil or similar agents on the plastic parts</li> <li>• Spray the piston-rods of the hydraulic cylinders with suitable anti-corrosion agents</li> <li>• Check the tightness of all bolt and plug-in connections (see the torque chart)</li> <li>• Check for any damage of the electric cables and replace if needed</li> </ul>					
<b>Brake system</b> <ul style="list-style-type: none"> <li>• Preserve the anti-freeze fluid for air-brake systems (about 0.1l), ethanol-free, before the last ride, use fluid recommended by the tractor manufacturer.</li> <li>• Secure the machine against movement by Scotch blocks.</li> <li>• Release the parking brake, release air from the air nozzle and close the brake lines. The service brake must be released during winter so that it does not get stuck on the brake drum</li> </ul>					
<b>Points of lubrication</b> Grease the points of lubrication according to the lubrication plan, use grease <b>KP2P-20 Lixx</b> , under DIN 51 502					
<b>!!! PREVENTION means removing the problem according to the plan, outside the season, without stress and comfortably before a secondary problem, an accident or a health hazard arises.</b>					

## 11 MACHINE STORAGE

Long-term machine shutdown:

- Store the machine under a roof if possible.
- Store the machine on a flat and solid surface with sufficient load capacity.
- Clean the machine before storing and conserve so that it is not damaged in any way during storage.
- Store the machine in the position with folded frames in the transport position. Store the machine on the axle and the storage leg, secure the machine against spontaneous movement using scotches or another suitable tool.
- When storing, lower the machine into the lower position using hydraulics.
- **The machine must not rest on the discs and the chisel units.** There is a risk of damage to the working discs or chisel breakage.
- Secure the machine against access of unauthorised persons.

## 12 MACHINE LUBRICATION SCHEDULE

 During machine maintenance and its lubrication, it is necessary to observe the safety regulations.

LUBRICATION POINT	INTERVAL	LUBRICANT
TOW BAR JOINT	<ul style="list-style-type: none"> <li>Once a week</li> <li>Always before the work with the machine</li> <li>Always after the end of the season and before storing the machine</li> </ul>	Grease class NGLI 2 with EP additives
TOWING LOOP	<ul style="list-style-type: none"> <li>Once a week</li> <li>Always before the work with the machine</li> <li>Always after the end of the season and before storing the machine</li> </ul>	Grease class NGLI 2 with EP additives
AXLE PINS	<ul style="list-style-type: none"> <li>Once a week</li> <li>Always before the work with the machine</li> <li>Always after the end of the season and before storing the machine</li> </ul>	Grease class NGLI 2 with EP additives

- Points of lubrication are marked:



- When it is difficult to apply the grease into the point of lubrication despite pressing the grease gun lever strenuously, try turning the joint while pressing the grease gun lever.

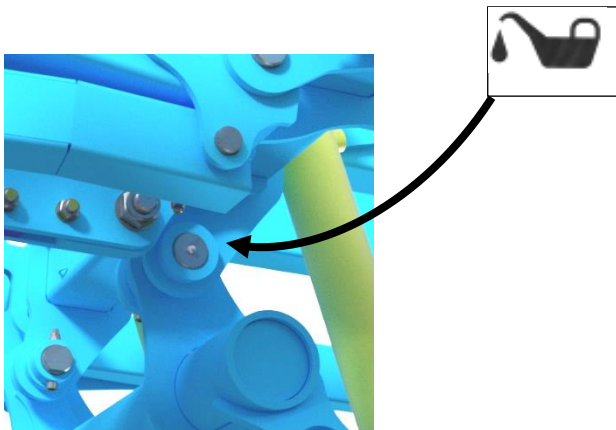
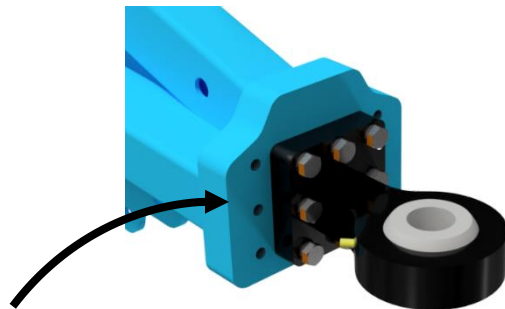



## **13 ENVIRONMENTAL PROTECTION**

- Regularly check the tightness of the hydraulic system.
- Preventively replace or repair hydraulic hoses, possibly further parts of the hydraulic system showing signs of damage, before oil leaks occur.
- Check the condition of hydraulic hoses and perform their timely replacement. The service life of hydraulic hoses includes the time, when they were stored.
- Handle oils and greases according to valid waste laws and regulations.

## **14 MACHINE DISPOSAL AFTER SERVICE LIFE EXPIRY**

- The operator must secure during machine disposal that steel parts and parts, in which hydraulic oil or lubricating grease moves are differentiated.
- Steel parts must be cut by the operator while observing safety regulations and handed over to the secondary raw material collection point. He must proceed with other parts according to valid laws about waste.

## **15 SERVICING AND WARRANTY CONDITIONS**

### **15.1 SERVICING**

- Servicing is secured by the dealer after consulting with the manufacturer, possibly directly by the manufacturer. Spare parts then using the sales network by individual sellers in the entire country. Use only the spare parts according to the spare parts catalogue officially issued by the manufacturer.

### **15.2 WARRANTY**

- 15.2.1 The manufacturer provides a warranty of 24 months for these machine parts: main frame, axle, and machine tow bar. For other parts of the machine, the manufacturer provides a warranty of 12 months. The warranty is provided from the date of sale of the new machine to the end user (consumer).
- 15.2.2 The warranty applies to hidden defects that will show in the warranty period with proper use of the machine and while fulfilling the conditions stated in the operating manual.
- 15.2.3 The warranty does not apply to wearable spare parts, i.e. regular mechanical wear and tear of replaceable parts of the working sections (shares, edges, etc.).
- 15.2.4 The warranty does not apply to indirect consequences of possible damage, such as service life decrease etc.
- 15.2.5 The warranty is bound to the machine and is not void upon an owner change.
- 15.2.6 The warranty is limited to the disassembly and assembly, possibly replacement or repair of the defective part. The decision, whether to replace or repair the defective part, is up to the contractual workshop of Farmet.
- 15.2.7 During the warranty period, only the authorised servicing technician of the manufacturer may perform repairs or other interventions into the machine. In the opposite case, the warranty will not be acknowledged. This provision does not apply to the replacement of wearable spare parts (see point 15.2.3).
- 15.2.8 The warranty is conditioned by using the genuine spare parts of the manufacturer.

(CZ) **ES PROHLÁŠENÍ O SHODĚ**  
 (GB) **CE CERTIFICATE OF CONFORMITY**  
 (D) **EG-KONFORMITÄTSERKLÄRUNG**  
 (F) **DÉCLARATION CE DE CONFORMITÉ**  
 (RU) **СЕРТИФИКАТ СООТВЕТСТВИЯ ЕС**  
 (PL) **DEKLARACJA ZGODNOŚCI WE**

1. (CZ) My (GB) We (D) Wir (F) Nous (RU) Мы (PL) My: **Farmet a.s.**  
 Jiřinková 276  
 552 03 Česká Skalice  
 Czech Republic  
 DIČ: CZ46504931  
 Tel/Fax: 00420 491 450136

(CZ) Vydáváme na vlastní zodpovědnost toto prohlášení. (GB) Hereby issue, on our responsibility, this Certificate. (D) Geben in alleiniger Verantwortung folgende Erklärung ab. (F) Publiions sous notre propre responsabilité la déclaration suivante. (RU) Под свою ответственность выдаем настоящий сертификат. (PL) Wydajemy na własną odpowiedzialność niniejszą Deklarację Zgodności.

2. (CZ) Strojní zařízení: - název : **Курпич**  
 (GB) Machine: - name : **Cultivator**  
 (D) Fabrikat: - Bezeichnung : **Grubber**  
 (F) Machinerie: - dénomination : **Cultivateur**  
 (RU) Сельскохозяйственная машина: - наименование : **Культиватор**  
 (PL) Urządzenie maszynowe: - nazwa : **Spulchniarka**

- typ, type : **TRITON**  
 - model, modèle : **TRITON 450 PS | TRITON 600 PS**  
 - PIN/VIN:

- (CZ) výrobní číslo :   
 - (GB) serial number  
 - (D) Fabriknummer  
 - (F) n° de production  
 - (RU) заводской номер  
 - (PL) numer produkcyjny

3. (CZ) Příslušná nařízení vlády: č.176/2008 Sb. (směrnice 2006/42/ES). (GB) Applicable Governmental Decrees and Orders: No.176/2008 Sb. (Directive 2006/42/ES). (D) Einschlägige Regierungsverordnungen (NV): Nr.176/2008 Slg. (Richtlinie 2006/42/ES). (F) Décrets respectifs du gouvernement: n°.176/2008 du Code (directive 2006/42/CE). (RU) Соответствующие постановления правительства: № 176/2008 Сб. (инструкция 2006/42/ES). (PL) Odpowiednie rozporządzenia rządowe: nr 176/2008 Dz.U. (Dyrektywa 2006/42/WE).

4. (CZ) Normy s nimiž byla posouzena shoda: (GB) Standards used for consideration of conformity: (D) Das Produkt wurde gefertigt in Übereinstimmung mit folgenden Normen: (F) Normes avec lesquelles la conformité a été évaluée: (RU) Нормы, на основании которых производилась сертификация: (PL) Normy, według których została przeprowadzona ocena: ČSN EN ISO 12100, ČSN EN ISO 4254-1.

(CZ) Schválil (GB) Approve by dne: 01.04.2021  
 (D) Bewilligen (F) Approuvé  
 (RU) Утвердил (PL) Uchwalif

V České Skalici dne: 01.04.2021

**Ing. Petr Lukášek**  
 technický ředitel  
 Technical director

**Ing. Karel Žďárský**  
 generální ředitel společnosti  
 General Manager

  
**Farmet a.s.**  
 Jiřinková 276  
 552 03 Česká Skalice  
 DIČ CZ46504931